

YAESU
The radio

FTM-7250DR

Operating Manual

**VHF/UHF DIGITAL/ANALOG TRANSCEIVER
C4FM/FM**



Contents

Safety Precautions (Be Sure to Read)	1	Memory Operation	26
FTM-7250DR Quick Reference Guide	3	Memory Storage.....	26
Introduction	4	Split Memory.....	27
Features of this radio.....	4	Memory Recall.....	27
Accessories & Options	5	Memory Recall from the Microphone Keypad.....	27
Supplied Accessories.....	5	Moving Memory Data to the VFO	28
Optional Accessories.....	5	Memory Only Mode.....	28
Installation	6	Masking Memories.....	28
Connecting the Microphone.....	6	Unmasking Memories.....	28
Connecting the Antenna.....	6	HOME Channel Memory.....	29
Mobile Installation.....	6	Changing the frequency of the home channel.....	29
Power connection.....	7	Scanning	30
Front Panel Controls & Switches	8	Basic Scanner Operation.....	30
Front Panel.....	8	Scan Resume Options.....	30
Rear Panel Connectors	10	Memory Skip Scanning.....	30
Rear Panel.....	10	Preferential Memory Scan.....	30
Microphone Switches	11	Programmable Memory Scan (PMS).....	30
Microphone (MH-48A6JA).....	11	Priority Channel Scanning (Dual Watch).....	30
Basic Operation	12	GM Function	31
Turning the Transceiver ON and OFF.....	12	What is the GM (Group Monitor) Function?.....	31
Inputting the call sign.....	12	Displaying all the stations using the	
Adjusting the Audio Volume Level.....	12	GM function.....	31
Adjusting the Squelch Setting.....	12	Reset Procedure/Clone	32
Selecting a Frequency Band.....	13	Reset Procedure.....	32
Frequency Navigation.....	13	Microprocessor Resetting.....	32
Using the Dial.....	13	Setup (Menu) Mode Resetting.....	32
Using the MH-48A6JA Microphone.....	13	Clone.....	32
Channel Step Selection.....	13	Connecting the WIRES-X feature	33
Selecting the communication mode.....	14	What is WIRES-X?.....	33
Setting the transmission mode		Connecting to a WIRES-X digital node	
when using the AMS function.....	15	(Recommended).....	33
Transmission.....	16	Connecting to the other node ID or the	
Adjusting the transmit power.....	17	other room ID.....	33
Lock Feature.....	17	Connect and communicate with WIRES-X	
Advanced Operation	18	in analog mode.....	36
About the Digital Group ID (DG-ID) feature.....	18	Disconnecting from the node or room.....	36
Register the DG-ID number in the		Miscellaneous Settings	37
DG-ID memory.....	19	Tone squelch feature.....	37
Recall and use the DG-ID number registered		Digital Code squelch (DCS) feature.....	37
in the DG-ID memory.....	20	Programming the Key Assignments.....	37
Digital Personal ID (DP-ID) feature.....	21	MIC Gain Setting.....	38
Registering the DP-ID to a DR-2X		Split Tone Operation.....	38
digital repeater.....	21	DTMF Operation.....	38
Register the transceivers.....	22	Setup (Menu) Mode	39
Deleting the registered DP-ID.....	23	Maintenance	42
Repeater Operation.....	24	Care and maintenance.....	42
Checking the Repeater Uplink (Input)		Replacing the fuse.....	42
Frequency.....	24	Specifications	43
Tone Calling (1750 Hz).....	24		
Weather Broadcast Reception (USA version only)...	25		
Severe Weather Alert Feature.....	25		

Safety Precautions (Be Sure to Read)

Be sure to read these important precautions, and use this product safely.

Yaesu is not liable for any failures or problems caused by the use or misuse of this product by the purchaser or any third party. Also, Yaesu is not liable for damages caused through the use of this product by the purchaser or any third party, except in cases where ordered to pay damages under the laws.

Types and meanings of the marks



DANGER

This mark indicates an imminently hazardous situation, which, if not avoided, could result in death or serious injury.



WARNING

This mark indicates a potentially hazardous situation, which, if not avoided, could result in death or serious injury.



CAUTION

This mark indicates a potentially hazardous situation, which, if not avoided, may result in minor or moderate injury or only property damage.

Types and meanings of symbols



These symbols signify prohibited actions, which must not be done to use this product safely. For example:  indicates that the product should not be disassembled.



These symbols signify required actions, which must be done to use this product safely. For example:  indicates that the power plug should be disconnected.



DANGER



Do not use the device in "regions or aircrafts and vehicles where its use is prohibited" such as in hospitals and airplanes.

This may exert an impact on electronic and medical devices.



Do not use this product while driving or riding a motorbike. This may result in accidents.

Make sure to stop the car in a safe location first before use if the device is going to be used by the driver.



Do not operate the device when flammable gas is generated.

Doing so may result in fire and explosion.



Never touch the antenna during transmission.

This may result in injury, electric shock and equipment failure.



Do not transmit in crowded places in consideration of people who are fitted with medical devices such as heart pacemakers.

Electromagnetic waves from the device may affect the medical device, resulting in accidents caused by malfunctions.



When an alarm goes off with the external antenna connected, cut off the power supply to this radio immediately and disconnect the external antenna from this radio.

If not, this may result in fire, electric shock and equipment failure.



Do not touch any liquid leaking from the liquid display with your bare hands.

There is a risk of chemical burns occurring when the liquid comes into contact with the skin or gets into the eyes. In this case, seek medical treatment immediately.



WARNING



Do not use voltages other than the specified power supply voltage.

Doing so may result in fire and electric shock.



Do not transmit continuously for long periods of time. This may cause the temperature of the main body to rise and result in burns and failures due to overheating.



Do not dismantle or modify the device.

This may result in injury, electric shock and equipment failure.



Do not handle the power plug and connector etc. with wet hands. Also do not plug and unplug the power plug with wet hands.

This may result in injury, liquid leak, electric shock and equipment failure.



When smoke or strange odors are emitted from the radio, turn off the power and disconnect the power cord from the socket.

This may result in fire, liquid leak, overheating, damage, ignition and equipment failure. Please contact our company amateur customer support or the retail store where you purchased the device.



Keep the power plug pins and the surrounding areas clean at all times.

This may result in fire, liquid leak, overheating, breakage, ignition etc.





Disconnect the power cord and connection cables before incorporating items sold separately and replacing the fuse.

This may result in fire, electric shock and equipment failure.

Safety Precautions (Be Sure to Read)

 **Never cut off the fuse holder of the DC power cord.**
This may cause short-circuiting and result in ignition and fire.

 **Do not use fuses other than those specified.**
Doing so may result in fire and equipment failure.

 **Do not allow metallic objects such as wires and water to get inside the product.**
This may result in fire, electric shock and equipment failure.

 **Do not place the device in areas that may get wet easily (e.g. near a humidifier).**
This may result in fire, electric shock and equipment failure.

 **When connecting a DC power cord, pay due care not to mix up the positive and negative polarities.**
This may result in fire, electric shock and equipment failure.

 **Do not use DC power cords other than the one enclosed or specified.**
This may result in fire, electric shock and equipment failure.



 **Do not bend, twist, pull, heat and modify the power cord and connection cables in an unreasonable manner.**
This may cut or damage the cables and result in fire, electric shock and equipment failure.

 **Do not pull the cable when plugging and unplugging the power cord and connection cables.**
Please hold the plug or connector when unplugging. If not, this may result in fire, electric shock and equipment failure.

 **Refrain from using headphones and earphones at a loud volume.**
Continuous exposure to loud volumes may result in hearing impairment.

 **Do not use the device when the power cord and connection cables are damaged, and when the DC power connector cannot be plugged in tightly.**
Please contact our company amateur customer support or the retail store where you purchased the device as this may result in fire, electric shock and equipment failure.

 **Follow the instructions given when installing items sold separately and replacing the fuse.**
This may result in fire, electric shock and equipment failure.

 **Do not use the device when the alarm goes off.**
For safety reasons, please pull the power plug of the DC power equipment connected to the product out of the AC socket.
 Never touch the antenna as well. This may result in fire, electric shock and equipment failure due to thunder.

CAUTION

 **Do not place this device near a heating instrument or in a location exposed to direct sunlight.**
This may result in deformation and discoloration.

 **Do not place this device in a location where there is a lot of dust and humidity.**
Doing so may result in fire and equipment failure.

 **Stay as far away from the antenna as possible during transmission.**
Long-term exposure to electromagnetic radiation may have a negative effect on the human body.

 **Do not wipe the case using thinner and benzene etc.**
Please use a soft and dry piece of cloth to wipe away the stains on the case.

 **Keep out of the reach of small children.**
If not, this may result in injuries to children.

 **Do not put heavy objects on top of the power cord and connection cables.**
This may damage the power cord and connection cables, resulting in fire and electric shock.

 **Do not transmit near the television and radio.**
This may result in electromagnetic interference.

 **For safety reasons, switch off the power and pull out the DC power cord connected to the DC power connector when the device is not going to be used for a long period of time.**
If not, this may result in fire and overheating.

 **When using the device in a hybrid car or fuel-saving car, make sure to check with the car manufacturer before using.**
The device may not be able to receive transmissions normally due to the influence of noises from the electrical devices (inverters etc.) fitted in the car.

 **Do not throw or subject the device to strong impact forces.**
This may result in equipment failure.

 **Do not place this device near magnetic cards and video tapes.**
The data in the cash card and video tape etc. may be erased.

 **Do not turn on the volume too high when using a headphone or earphone.**
This may result in hearing impairment.

 **Do not use optional products other than those specified by our company.**
If not, this may result in equipment failure.

 **Do not place the device on an unsteady or sloping surface, or in a location where there is a lot of vibration.**
The device may fall over or drop, resulting in fire, injury and equipment failure.

 **Do not stand on top of the product, and do not place heavy objects on top or insert objects inside it.**
If not, this may result in equipment failure.

 **Do not use a microphone other than those specified when connecting a microphone to the device.**
If not, this may result in equipment failure.

 **Do not touch the heat radiating parts.**
When used for a long period of time, the temperature of the heat radiating parts will get higher, resulting in burns when touched.

 **Do not open the case of the product except when replacing the fuse and when installing items sold separately.**
This may result in injury, electric shock and equipment failure.

② VOL Knob

Adjusts the audio volume level.

③ Frequency DIAL Knob

Selects the operating Frequency.

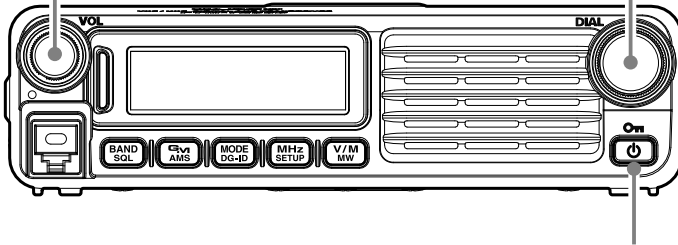

① Power Switch

Press and hold for one second.

④ Transmission Switch

Speak into the microphone in a normal voice level while pressing this switch.

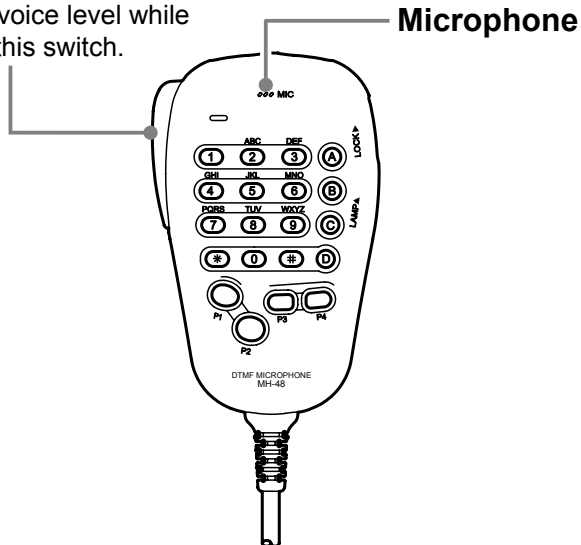

Features of this radio

- 144/430 MHz dual band mobile radio, equipped with a C4FM communication modem.
- 50 Watts of power output, with selection of three power levels for every operating situation.
- Clear audio and data communication is achieved using the C4FM modem functions.
- Expanded receiver coverage: 108.000 MHz - 579.995 MHz.
- With the GD-ID (Digital Group ID) feature, the Group Monitor (GM) feature enables automatically locating, and communicating with other stations that have the same DG-ID number within contact range, by utilizing a matching group ID number from 00 to 99.
- The Digital Personal ID (DP-ID) feature supports communication specifically with transceivers registered with the individual ID information. The DP-ID is different for each transceiver and is included in each C4FM transmission.
- Easily connect with the WIRES-X linking system.
- Keyboard entry of operating frequencies from the microphone.
- 225 memories (199 “basic” memory channels, 10 sets of band-edge memory channels, and 6 “Home” channel) which can store repeater shifts, odd repeater shifts, CTCSS/DCS tones, and 8-character Alpha-Numeric labels for easy channel recognition.
- Built-in CTCSS and DCS Encoder/Decoder circuits.
- Extensive Menu system, which allows customization of a number of transceiver performance characteristics.
- Equipped with the GM (Group Monitor) function.

Additional features include a transmit Time-Out-Timer (TOT), Automatic Power-Off (APO), and Automatic Repeater Shift (ARS). Also included is an RF Squelch circuit that allows the owner to set the squelch to open at a programmed setting of the S-Meter, thus reducing guesswork in setting the squelch threshold.

Congratulations on your purchase of the FTM-7250DR! Whether this is your first rig, or if Yaesu equipment is already the backbone of your station, the Yaesu organization is committed to ensuring your enjoyment of this high-performance transceiver. It should provide you with many years of satisfying operation. Our dealer network and technical support personnel stand behind every product we sell, and we invite you to contact us should you require technical advice or assistance.

We recommend that you read this manual in its entirety prior to installing the FTM-7250DR, so that you fully understand the capabilities of your new transceiver.

Supplied Accessories

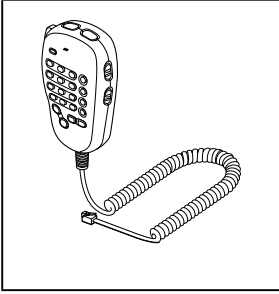

DTMF Microphone
MH-48A6JA

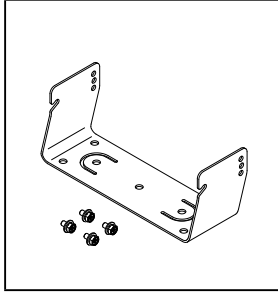

Mobile Mounting Bracket
(Attachment screw set)

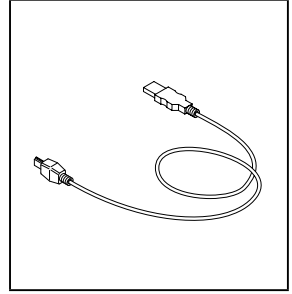

USB cable

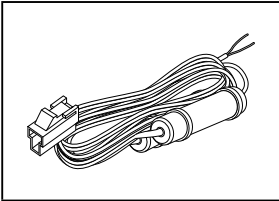

DC power cable
(with fuse attached)
(USA, Asian version)

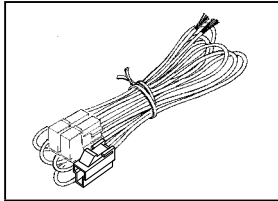

DC power cable
(with fuse attached)
(European version)

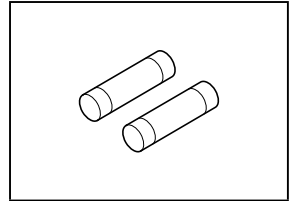

Spare fuse (15 A)
(USA, Asian version)

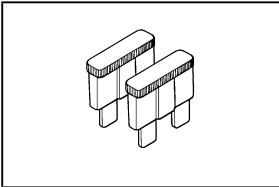

Spare fuse (15 A)
(European version)

Operating Manual (this manual)

Optional Accessories

MH-42C6J	Microphone
MH-48A6JA	DTMF Microphone (Same as the one provided)
MLS-100	High-Power External Speaker
FP-1030A	AC Power Supply (25 A) (USA and Asian market only)
FP-1023	AC Power Supply (23 A) (USA market only)

Installation

Connecting the Microphone

Connect the supplied MH-48A6JA microphone to the FTM-7250DR.

Plug the microphone connector into the MIC jack on the front panel until it clicks.

Note: When disconnecting the microphone, pull the cable while pressing the connector latch.

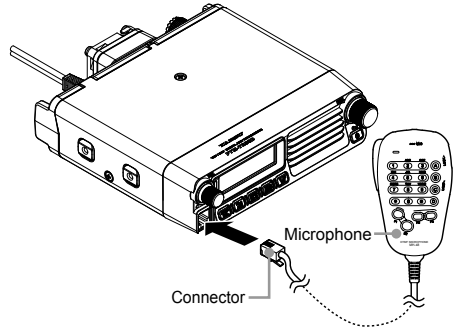

Connecting the Antenna

Connect the coaxial cable to the body.

Plug the coaxial cable jack into the ANT terminal on the rear panel of the body, then rotate and tighten it.

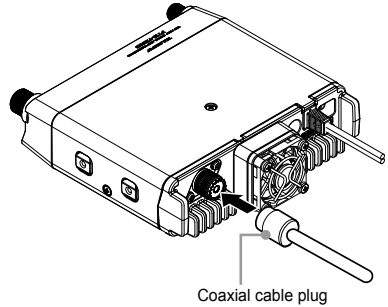

Mobile Installation

The FTM-7250DR must only be installed in vehicles having a 13.8 Volt negative ground electrical system. Mount the transceiver where the display, controls, and microphone are easily accessible, using the supplied mounting bracket.

The transceiver may be installed in almost any location, but should not be positioned near a heating vent nor anywhere where it might interfere with driving (either visually or mechanically).

Make sure to provide plenty of space on all sides of the transceiver so that air can flow freely around the radio's case. Refer to the diagrams showing proper installation procedures.

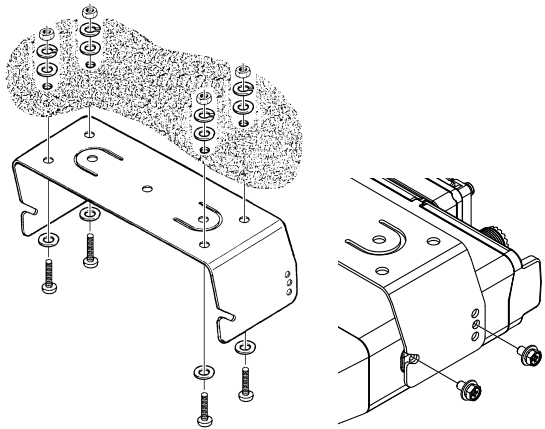

Power connection

To minimize voltage drop and avoid blowing the vehicle's fuses, connect the supplied DC power cable directly to the battery terminals. Do not attempt to defeat or bypass the DC cable fuse - it is there to protect you, your transceiver, and your vehicle's electrical system.

Operation of the FTM-7250DR from an AC line requires a power source capable of providing at least 20 Amps continuously at 13.8 Volts DC. The FP-1023 (USA market only) and FP-1030A (USA/Asian market only) AC Power Supplies are available from your Yaesu dealer to satisfy these requirements. Other well-regulated power supplies may be used as well, if they meet the above voltage and current specifications.

Warning!

- **Never apply AC power to the power cable of the FTM-7250DR, nor DC voltage greater than 15.8 Volts. When replacing the fuse, only use a 15 A fuse. Failure to observe these safety precautions will void the Limited Warranty on this product.**
- **Do not use a DC power supply cable other than the one that is supplied or specified.**
- **Do not place anything on the DC power supply cable or step on it.**
- **Do not use the DC power supply cable with the fuse holder cut off.**
- **Do not reverse the polarity (positive and negative) when connecting the battery.**

- Connect the **RED** power cable lead to the **POSITIVE (+)** terminal, and the **BLACK** power cable lead to the **NEGATIVE (-)** terminal. If you need to extend the power cable, use #12 AWG or larger insulated, stranded copper wire. Solder the splice connections carefully, and wrap the connections thoroughly with insulating electrical tape.

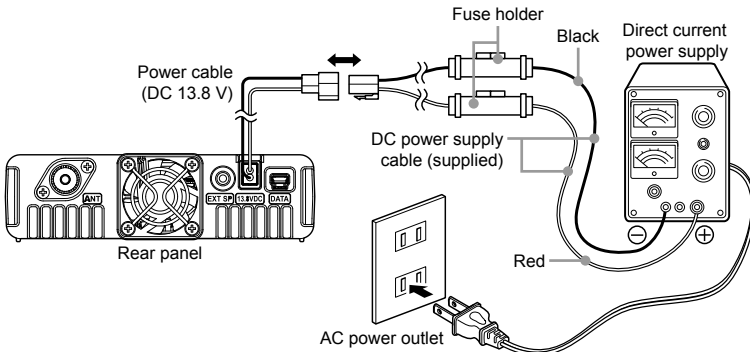
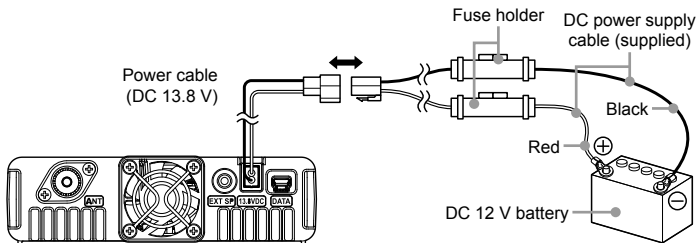

Front Panel Controls & Switches

Front Panel

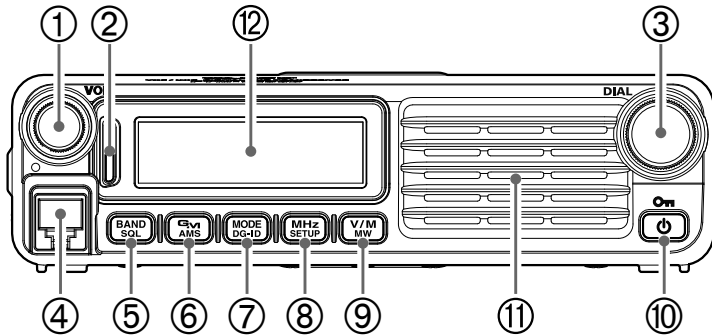

① VOL knob

Turning the knob clockwise increases the volume, whereas turning it counterclockwise decreases the volume.

② Mode/Status indicator

Indicates the transmission/reception status with a two-color combination on the upper and lower portions of the mode/status indicator.

Communication status		Upper portion	Lower portion
Receiving analog audio		Green	Green
Transmitting analog audio		Red	Red
Receiving digital audio		Green	Blue
Transmitting digital audio		Red	Blue
Receiving digital data		Green	White
Receiving signals with unmatched audio or data conditions*		Green	Blink in Blue
GM function during operation	The other station is within the communication range	-	Light Blue
	Transmitting GM confirmation signal to the other station within the communication range		Blue

- ※ • Receiving signals with unmatched tone frequency or DCS code.
 • Receiving analog audio in digital mode.
 • Receiving signals with unmatched DG-ID in digital mode.
 • Receiving a signal level less than the RF Squelch S-meter level setting.

③ DIAL Knob

- Allows setting the operating band frequency.
Turning clockwise increases the frequency, whereas turning counterclockwise decreases the frequency.
- Allows selecting the desired items for setup, memory registration, group monitoring operation, etc.

④ MIC Jack

Connect the provided microphone cable.

Front Panel Controls & Switches

⑤ [BAND(SQL)] key

A brief press of this key moves operation to the next-highest frequency band. Press and hold in this key to adjusted the squelch level.

⑥ [GM(AMS)] key

Pressing this key to activate the GM (Group Monitor) function.

Press and hold this key to display the transmit mode setting when using the AMS function.

⑦ [MODE(DG-ID)] key

Briefly pressing each time switches the operating band communication mode.

Press and hold in this key to select the DG-ID number registered in the DG-ID memory.

Note: For details, see “Recall and use the DG-ID number registered in the DG-ID memory” on 20.

⑧ [MHz(SETUP)] key

This key allows tuning in 1 MHz steps (the MHz digits will blink on the display).

Press and hold this key to activate the Setup (Menu) Mode.

⑨ [V/M(MW)] key

Pressing this key briefly, switches between VFO mode, memory mode, and HOME channel.

Press and hold the key to display the memory registration screen.

⑩ Power/Lock key

Press and hold in this key to switch the power between ON and OFF. Briefly pressing the key while the transceiver is turned ON engages or releases the key lock.

⑪ Speaker

The internal speaker is located here.

⑫ LCD Display

The main digits on the display may show the operating frequency, memory name, or any of many parameters during Menu setup.

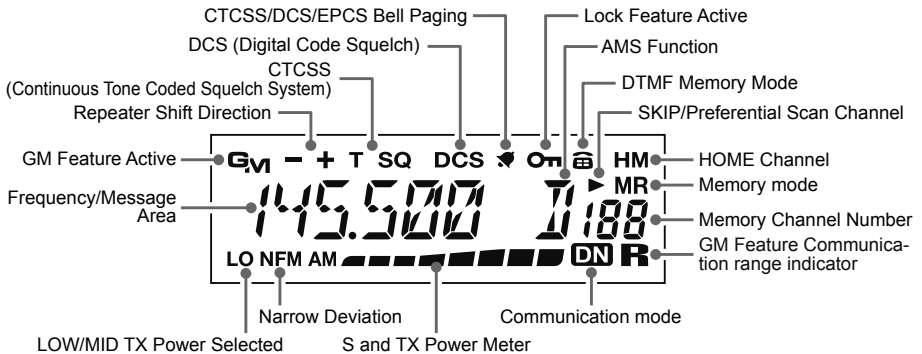

Rear Panel Connectors

Rear Panel

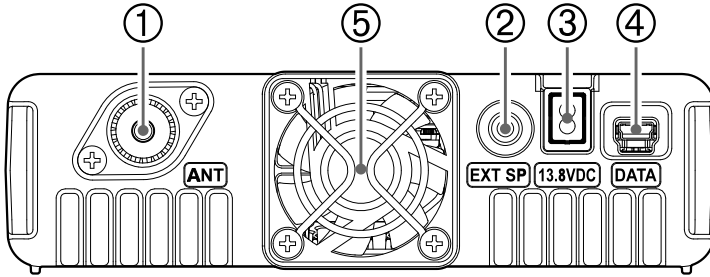

① ANT Coaxial Socket

This is the M-type coaxial connector to connect 144 MHz band and 430 MHz band antennas (50 ohms). Make sure the antenna is designed specifically for use on the operating frequency.

② EXT SP Jack

This 2-contact 3.5-mm mini phone jack provides receiver audio output for an optional external speaker. The audio impedance is 4 Ohms, and the level varies according to the setting of the front panel **VOL** control. Inserting a plug into this jack disables audio from the transceiver's internal speaker.

③ 13.8 V DC Cable

Connect the provided DC power supply cable (with fuse attached).

④ DATA Jack

Use this jack when updating the firmware. When a new firmware update for the FT-M-7250DR is available, go to the YAESU website to download the programming data and update the FT-M-7250DR to its newest state.

⑤ Cooling Fan

Microphone (MH-48A6JA)

① PTT Switch

Press this switch to transmit, and release it to receive.

② KEY Pad Buttons

1 to 0: Enters the numerals.

*****: Switches between VFO mode, Memory mode, and HOME channel.

#: Scans the programmed memory channels.

A: Changes tuning to 1 MHz steps.

B: Changes the operating band.

C: Adjusts the squelch level.

D: Changes the transmit power.

③ [P1] / [P2] keys

[P1] key

Press this key to recall the DG-ID memory.

[P2] key

Press and hold this key to enter the DG-ID memory screen.

[P3] / [P4] keys

These two keys are user programmable, allowing quick access to features used often. The default functions are described below.

[P3] key (WIRES-X)

Press this key to activate the Wires-X feature.

[P4] key (WX CH / T CALL)

In the USA version, pressing this key activates the WX function.

In the European/Asian version, pressing this key activates T CALL (1750 Hz) for repeater access.

You can reprogram the [P3] and [P4] keys for other functions, if desired.

Note: For details, refer to the Advanced Manual (download from the Yaesu website).

④ MIC

Speak into this port during transmission.

⑤ [UP] / [DWN] keys

Press (or hold in) either of these keys to tune (or scan up or down) the operating frequency or through the memory channels. In many ways, these keys emulate the function of the (rotary) **DIAL** knob.

⑥ LOCK switch

This switch locks out the Microphone keys (except for the keypad and **PTT** switch).

⑦ LAMP switch

This switch illuminates the Microphone keypad.

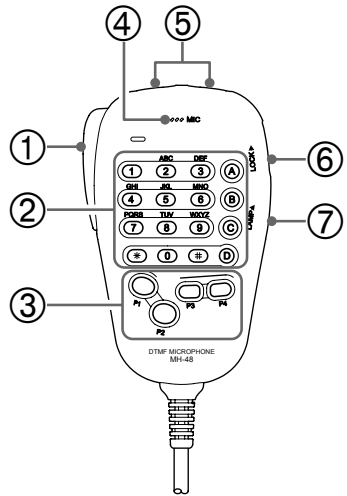

Basic Operation

Turning the Transceiver ON and OFF

1. To turn the transceiver ON, press and hold the **PWR/LOCK** key.
2. To turn the transceiver OFF, again press and hold the **PWR/LOCK** key.

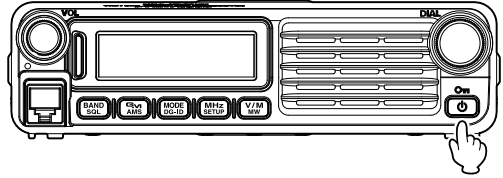

You can compose any desired Opening Message (up to 8 characters) via Setup Menu Item “**OPEN MSG 28**” see 40 for details.

Inputting the call sign

A screen requesting input of a call sign appears when turning the transceiver on for the first time, or after resetting the transceiver. The call sign is used to identify the transmitting station when communicating in digital mode.

1. Press the [**V/M(MW)**] key.
2. Rotate the **DIAL** knob to select characters, then press the [**V/M(MW)**].

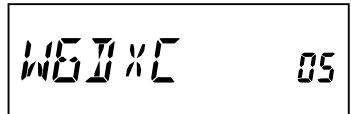

By rotating the **DIAL** knob, you can switch the characters in the following order:

“space” ► “-” ► “/” ► “0” to “9” ► “A” to “Z”

- Up to 10 characters (alphanumeric characters including hyphen) can be entered.
 - “space”, “-”, and “/” are not selectable for the first character.
3. Press and hold the [**MHz(SETUP)**] key to save the call sign and exit to normal operation.

Adjusting the Audio Volume Level

Rotate the **VOL** knob to adjust the receiver volume. Clock-wise rotation increases the audio output level.

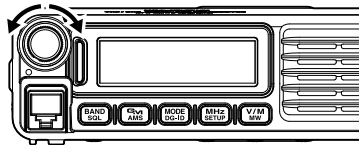

Adjusting the Squelch Setting

1. Press and hold the [**BAND(SQL)**] key, then rotate the **DIAL** knob to select the Squelch level.
2. Press the [**BAND(SQL)**] key again.

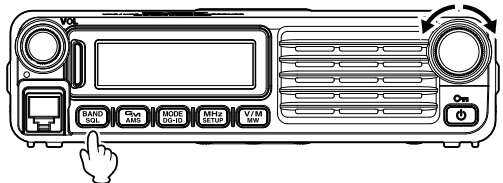

Note: A special “RF Squelch” feature is provided on this radio. This feature allows setting the squelch so that only signals exceeding a certain S-meter level will open the squelch. For details, refer to the Advanced Manual (download from the Yaesu website).

Selecting a Frequency Band

Press the [MHz(SETUP)] key to select the desired frequency band.

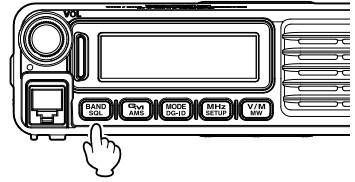

Frequency ranges for each frequency band are below:

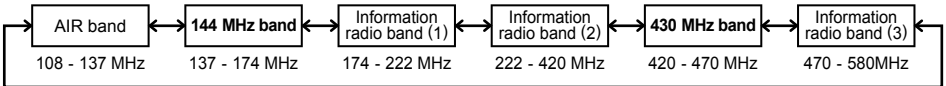

Frequency Navigation

Using the Dial

Rotating the **DIAL** knob allows tuning in the pre-programmed steps. Clockwise rotation tunes the frequency upwards, whereas counterclockwise rotation tunes the frequency downwards.

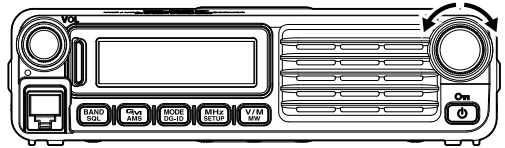

- Press the [MHz(SETUP)] key momentarily, then rotate the **DIAL** knob, to change the frequency steps to 1 MHz per step.

Using the MH-48A6JA Microphone

Using the [UP] and [DWN] key:

Pressing [UP] momentarily, tunes the frequency upwards. Whereas pressing [DWN] momentarily tunes the frequency in the downward direction.

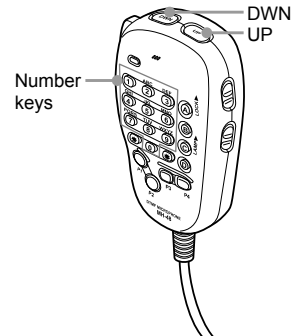

Using the number keys:

Use the [0] to [9] number keys to directly input the frequency.

There is no “decimal point” key on the MH-48A6JA keypad. However, there is a short-cut for frequencies ending in zero:

press the [#] key after the last non-zero digit.

Examples: To enter 446.520 MHz, press [4] ➡ [4] ➡ [6] ➡ [5] ➡ [2] ➡ [0]

To enter 446.000 MHz, press [4] ➡ [4] ➡ [6] ➡ [#]

Channel Step Selection

The frequency tuning step of the **DIAL** and the microphone [UP]/[DWN] keys can be changed.

Note: See Setup Menu Item “STEP 45” on 41

Basic Operation

Selecting the communication mode

The FTM-7250DR transceiver is equipped with the AMS (Automatic Mode Select) function which automatically selects from two modes of transmission corresponding to the signal being received.

The transmit mode is selected according to the received signal so that C4FM digital signals, and analog signals are received and transmitted automatically.

Press [**MODE(DG-ID)**] key to display “**DN**” (blinks) icon on the screen.

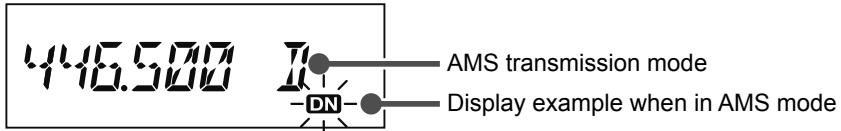

To operate in fixed communication mode, press [**MODE(DG-ID)**] key to switch the communication mode.

Each time [**MODE(DG-ID)**] key is pressed, the communication mode changes in the following order:

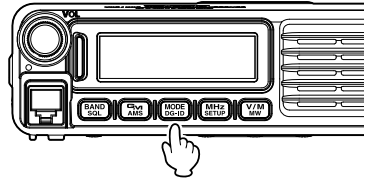

➡ AMS (“**DN**” blinks) ➡ V/D (DN) (“**DN**” lights up) ➡
 ➡ VW* (“**DN**” lights up) ➡ FM (no icon) ➡

Communication mode	Icon	Description of modes
AMS (Automatic Mode Select)	DN (blinks)	Transmit mode is automatically selected from 3 types according to the signal received. The AMS function operation can be changed from the Setup menu setting. See “Setting the transmit mode when using the AMS function (DIG AMS 12)” on 39
V/D (DN) Mode (Voice/Data simultaneous transmission mode)	DN (light up)	Calls are less prone to interruptions due to detection and correction of voice signals during digital voice signal transmission. This is the standard mode for C4FM Digital.
Voice FR (VW) Mode* (Voice Full Rate mode)		High speed data communication using entire 12.5 kHz band. Enables high-quality voice communication.
Analog FM Mode	no icon	Analog communication using FM mode. Effective when the signal is weak and audio is susceptible to interruption in digital mode.

※: When the Setup Menu item “**DIG VW 13**” is set to “ON” (factory default is “OFF”), the Voice FR (VW) may be selected.

Setting the transmission mode when using the AMS function

The AMS function will automatically set the receiver to the mode of the received signal, but the transmission mode may be fixed regardless of the received mode.

1. Press and hold the **[GM(AMS)]** key.
2. Rotate the **DIAL** knob to select the desired transmission mode as follows.

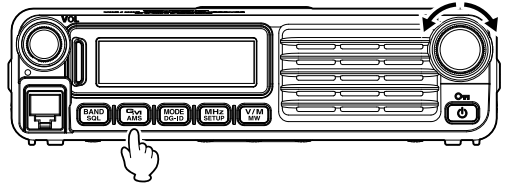

AUTO (“DN” blinks: 0.5 sec on, 0.5 sec off)

Automatically selects one of the two communication modes according to the received signal.

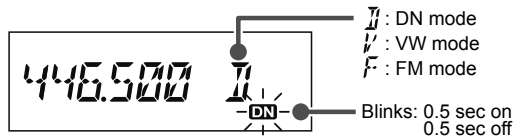

TXMANUAL (“DN” blinks: 1 sec on, 0.5 sec off)

Automatically selects one of the two communication modes according to the received signal. Briefly pressing **PTT** on the microphone switches between digital mode and analog mode.

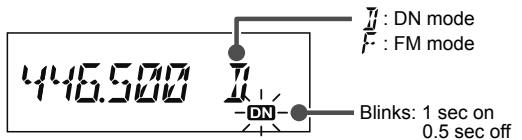

TX FMFIX (“DN” blinks: 0.5 sec on, 0.5 sec off)

Automatically selects one of the two communication modes according to the received signal. Always switches to FM mode for transmission.

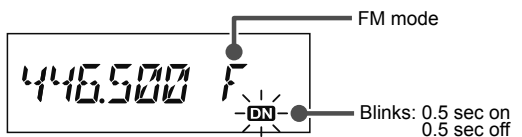

TX DIGTL (“DN” blinks: 0.5 sec on, 0.5 sec off)

Automatically selects one of the two communication modes according to the received signal. Always switches to DN mode for transmission.

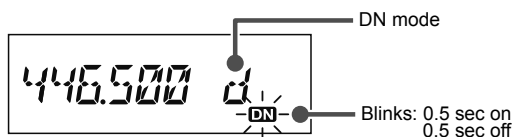

TX VWFIX (“DN” blinks: 0.5 sec on, 0.5 sec off)

Note: When the Setup Menu item “DIG VW 13” is set to “ON” (factory default is “OFF”), the “TX VWFIX” may be selected.

Automatically selects one of the two communication modes according to the received signal. Always switches to VW mode for transmission.

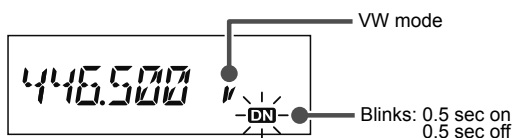

3. Press the **[GM(AMS)]** key to save the new setting and exit to normal operation.

Basic Operation

Transmission

1. Press and hold **PTT** switch on the microphone.

In analog mode, both the upper and lower portions of the mode/status indicator light red.

In digital mode, the upper portion of the mode/status indicator lights red and the lower portion of the mode/status indicator lights blue.

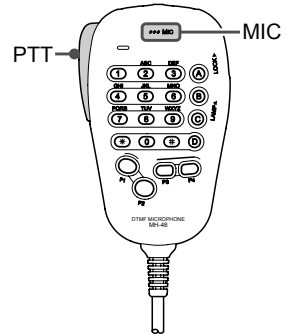

Analog mode: Both the upper and lower portions light red

Digital mode: The upper portion lights red and the lower portion lights blue

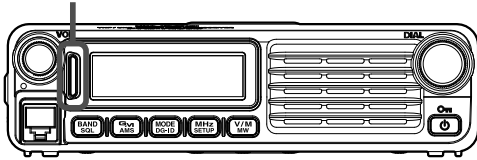

2. Speak into **MIC** on the microphone.

Note: Keep the microphone about 5 cm away from your mouth.

The sensitivity (gain) of the microphone can be adjusted, use the Setup Menu Item "**MIC GAIN 25**" see 40 for details.

3. Release **PTT** switch.

The transmit mode/status indicator turns off and the transceiver returns to the receive mode.

Caution: Do not continue transmitting for a prolonged period. The transceiver may overheat, resulting in malfunction or injury.

Note: "ERROR" appears if you attempt to transmit on an unavailable frequency.

Adjusting the transmit power

When communicating with a nearby station, the transmit power level may be reduced to save on energy consumption.

1. Press the **[D]** key on the microphone.
2. Rotate the **DIAL** knob or press the **[UP]/[DWN]** key on the microphone to select the transmit power.

Note: The default setting: HIGH

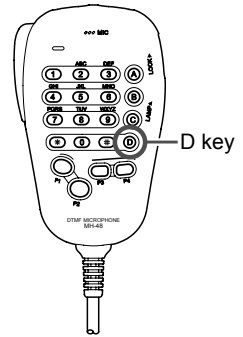

HIGH (50 W)



MID (25 W)

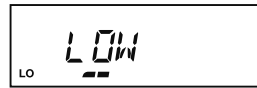

LOW (5 W)

3. Press the **[D]** key to save the new setting and exit to normal operation.

Lock Feature

To activate the key-lock feature, press the **[Power(Lock)]** key. The “**On**” icon will appear on the LCD.

To cancel key-lock, press the **[Power(Lock)]** key again.

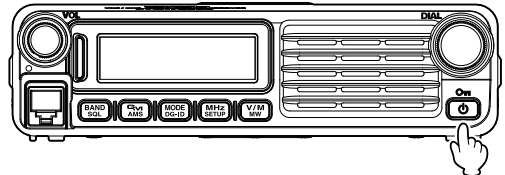

To select which keys are locked, use the Setup Menu Item “**LOCK 24**” see 40 for details.

About the Digital Group ID (DG-ID) feature

The DG-ID function can set up two-digit DG-ID numbers from “00” to “99” separately for Transmit and Receive. By setting both transmit and receive to “00” (default), you can communicate with all the other stations in the digital C4FM mode.

By matching the transmit DG-ID number to the uplink DG-ID number set in the club DR-2X/XE System Fusion II digital repeater, you can access the digital repeater DR-2X/XE used in the club.

For communication only among a group of friend’s transceivers, you can all match the same DG-ID number; then only your friend’s voices will be heard. Also, by using the GM function you can check whether stations with the same DG-ID are in the communication range. The FTM-7250DR may register transmit and receive DG-ID numbers in the DG-ID memories (up to 10 pairs), and then use the [P1] / [P2] keys on the microphone to easily recall a Group ID.

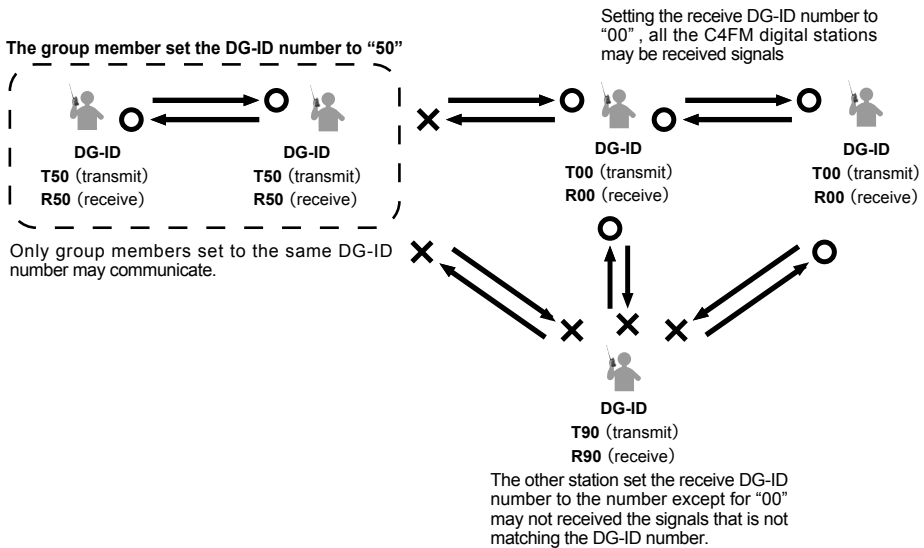

Register the DG-ID number in the DG-ID memory

Example: Enter the transmit DG-ID number “50” and the receive DG-ID number “00” into the DG-ID memory “01”

1. Press and hold the **[P2]** key on the microphone.
The DG-ID memory number at the bottom right of the screen blinks.
2. Rotate the **DIAL** knob or press the **[UP]/[DWN]** key on the microphone to select the DG-ID memory number to be stored to the “01” register.
3. Press the **[P2]** key on the microphone.
The transmit DG-ID number “T00” blinks.
4. Rotate the **DIAL** knob or press the **[UP]/[DWN]** key on the microphone to set the transmit DG-ID number to “T50”.



5. Press the **[P2]** key on the microphone.
The transmit DG-ID number blinks.
6. Rotate the **DIAL** knob or press the **[UP]/[DWN]** key on the microphone to set the receive DG-ID to “R00”.
7. Press the **[P2]** key on the microphone.
 - The input screen of the DG-ID tag is displayed.

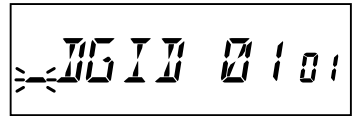

- Use the numeric keys on the microphone or the **DIAL** knob to input the characters of the DG-ID tag. Up to 8 characters can be entered.
Press the **[P3]** key on the microphone or **[BAND(SQL)]** key to move the cursor to the left.
Press the **[P4]** key on the microphone or **[V/M (MW)]** key to move the cursor to the right.
8. Press and hold the **[P2]** key on the microphone to save the setting and return to normal operation.

Notes:

- The DG-ID memory “00” is fixed at “T00 R00” and cannot be changed.
- By pressing and holding the **[P2]** key on the microphone in the middle of the setting, the setting so far will write and then return to the normal screen.
- When the **[P2]** key on the microphone is not pressed while writing, after five seconds elapse the operation will return to the normal screen without saving the setting.

Advanced Operation

Recall and use the DG-ID number registered in the DG-ID memory

1. Press the **[P1]** key on the microphone, the information of the current DG-ID is displayed.
2. Rotate the **DIAL** knob or press the **[UP]/[DWN]** key on the microphone to select the number of DG-ID List to recall.
3. Press the **PTT** switch to select the DG-ID number and return to the frequency display screen. Or if five seconds passes, the selected screen will return to frequency screen automatically.
 - When using the DG-ID memory, the tag of the DG-ID memory being used is displayed every 3 seconds.
 - If the DG-ID memory is "00", DG-ID memory tag is not displayed.
4. Press the **[P1]** key on the microphone to switch to the DG-ID number display as shown below. When the DG-ID memory is "00", no DG-ID tag is displayed, only the DG-ID number "00" is displayed.

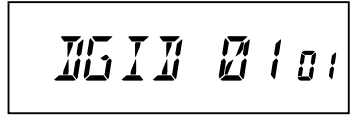

DG-ID Tag display



DG-ID Number display

DG-ID Tag display ⇨ DG-ID Number display ⇨ Normal Screen

- If there is no operation for more than five seconds, the display returns to the normal frequency display screen.
- Press and hold the **[P1]** key on the microphone while on the frequency display screen. The DG-ID memory returns to DG-ID memory "00" with one touch.

Digital Personal ID (DP-ID) feature

Every C4FM digital transmit communication contains the individual ID information (Radio ID) of each transceiver. The DP-ID function uses this individual ID information.

When communicating with another transceiver, if the DP-ID of the stations are registered in each other's transceivers, they can communicate even if the DG-ID numbers are different.

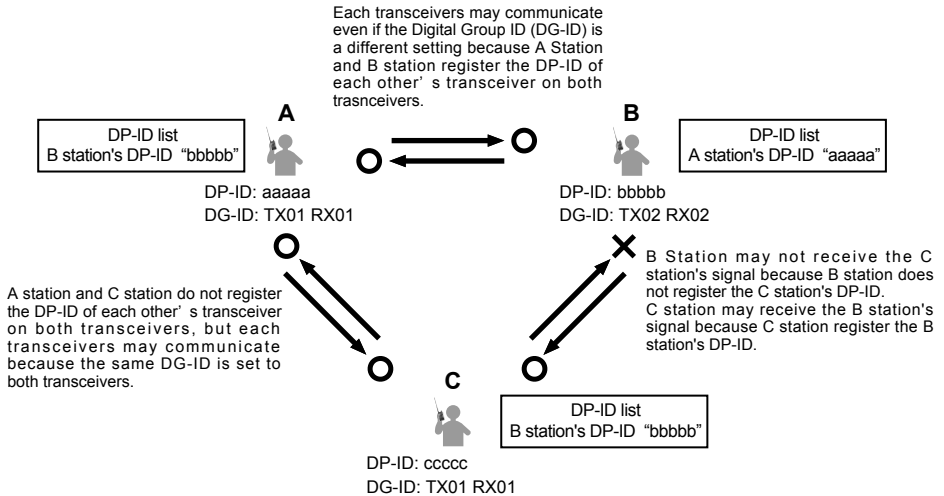

Registering the DP-ID to a DR-2X digital repeater

Note: To register the transceiver DP-ID in the System Fusion II, DR-2X C4FM digital repeater, refer to the instruction manual of the DR-2X.

By registering the transceiver's DP-ID in the DR-2X, you can remotely control the settings and functions of DR-2X. Remote control cannot be performed from a transceiver that does not register the DP-ID, so it is possible to securely manage repeaters.

DR-2X Remote Control Feature

- Activate the repeater operation
- Deactivate the repeater operation
- Set the repeater to C4FM mode
- Set the transmit power
- Voice Message Control (Rec / Play / Stop)
- Set the Emergency Call

Advanced Operation

Register the transceivers

1. Press and hold the [MHz(SETUP)] key to enter the Setup Menu.
2. Rotate **DIAL** knob to select “**DPID LST 15**”.
3. Press the [MHz(SETUP)] key.



The LCD display shows the text "DPID LST 15" in a digital font.

4. While the DP-ID list is displayed, a transmission in the digital C4FM mode from the other transceiver will register the DP-ID.

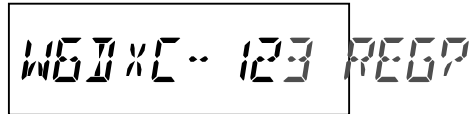

The LCD display shows the text "W6JXC-123 REGP" in a digital font.

When a signal from the other station is received, the call sign is displayed on the LCD.

Notes:

- When a signal from the already registered transceiver is received, the display of DP-ID list does not change.
 - When registering a transceiver already registered with a different call sign, the call sign registered in the DP-ID list is changed to registrar the new call sign.
5. Press and hold the [MODE(DG-ID)] key to save the setting.
 - When registering in the DP-ID list is finished, “COMPLETE” is displayed, then the display returns to the DP-ID list screen.
 - To continue operating without registering the DP-ID, press the [MODE(DG-ID)] key.
 - If registering several DP-IDs, repeat steps 4 to 5.
 - A maximum of 24 stations may be registered.
 6. Press and hold the [MHz(SETUP)] key to return to normal operation.

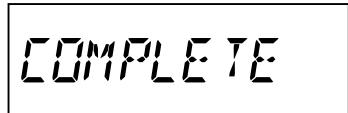

The LCD display shows the text "COMPLETE" in a digital font.

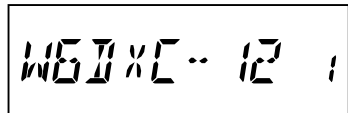

The LCD display shows the text "W6JXC-123" in a digital font.

Register the DP-ID of all the transceivers in the group to another transceiver using the same operation.

Notes:

- Once the DP-ID is registered, the DP-ID is stored until the DG-ID is deleted.
- Register with the another transceiver while each other's transceivers are nearby.

Deleting the registered DP-ID

1. Press and hold the [MHz(SETUP)] key to enter the Setup Menu.
2. Rotate **DIAL** knob to select “DPID LST 15”.
3. Press the [MHz(SETUP)] key.
The DP-ID List is displayed.
4. Rotate the **DIAL** knob to select the call sign.
5. Press and hold the [MODE(DG-ID)] key
The confirmation screen is displayed.
6. Press and hold the [MODE(DG-ID)] key again to delete.
 - When deleting in the DP-ID list is finished, “COMPLETE” is displayed for three seconds, then the display returns to the DP-ID list screen.
 - To return to normal operation without deleting the DP-ID, press the [MODE(DG-ID)] key.
 - If deleting several DP-IDs, repeat steps 4 to 6.
7. Press and hold the [MHz(SETUP)] key to return to normal operation.

A rectangular LCD display showing the text "DPID LST 15" in a digital font.

A rectangular LCD display showing the text "W6JXC-12 1" in a digital font.

A rectangular LCD display showing the text "DELETE? 1" in a digital font.

A rectangular LCD display showing the text "COMPLETE" in a digital font.

Repeater Operation

The FTM-7250DR includes the ARS (Automatic Repeater Shift) function, which permits communication through repeaters automatically, by simply setting the receiver to the repeater frequency.

1. Tune to the repeater frequency.
2. Press the **PTT** switch to transmit.

During transmission, radio waves having an 100.0 Hz* tone signal are emitted on the frequency offset from the receive frequency by 0.6 MHz* (144 MHz) or 5 MHz (430 MHz)*.

*: Depends on the transceiver version.

Note: From the Setup Menu, you can change the repeater setting.

RPT ARS 35 ➡ Deactivates the ARS function.

RPT FREQ 36 ➡ Allows changing the repeater shift frequency offset.

RPT SFT 37 ➡ Allows setting the repeater shift direction.

Checking the Repeater Uplink (Input) Frequency

It is often helpful to be able to check the uplink (input) frequency of a repeater, to see if the calling station is within direct (“Simplex”) range.

Note: For details, refer to the Advanced Manual (download from the Yaesu website).

Tone Calling (1750 Hz)

If your transceiver is FTM-7250DE (European version), press and hold in the program key **[P4]** of the microphone (MH-48) to generate a 1750 Hz burst tone to access the European repeater. The transmitter will automatically be activated, and a 1750 Hz audio tone will be superimposed on the carrier. Once access to the repeater has been gained, you may release the **[P4]** key, and use the **PTT** switch for activating the transmitter thereafter.

Weather Broadcast Reception (USA version only)

The FTM-7250DR includes a unique feature which allows reception of weather broadcasts in the 160 MHz frequency range. Ten standard Weather Broadcast channels are preloaded into a special memory bank.

To listen to a Weather Broadcast Channel (Example: When “WX CH” is assigned to [P4]):

1. Press the Microphone [P4] key to recall the Weather Broadcast channels.

Note: In the USA model, the [P4] key one of the programmable keys, is assigned (default setting) as the “WX Broad-cast” one-touch access key. Please note that if you change/assign another function to the [P4] key, one-touch access to the WX channel will be unavailable.

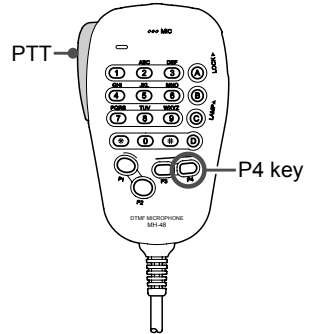

2. Turn the **DIAL** knob to select the desired Weather Broadcast channel.

CH	Frequency	CH	Frequency
1	162.550 MHz	6	162.500 MHz
2	162.400 MHz	7	162.525 MHz
3	162.475 MHz	8	161.650 MHz
4	162.425 MHz	9	161.775 MHz
5	162.450 MHz	10	163.275 MHz

3. To scan the other channels for activity, press the Microphone **PTT** switch.
4. To exit to normal operation, press the [P4] key again. Operation will return to the VFO or Memory channel in operation before you began Weather Broadcast operation.

Severe Weather Alert Feature

In the event of extreme weather disturbances, such as storms and hurricanes, NOAA (the National Oceanic and Atmospheric Administration) sends a weather alert accompanied by a 1050 Hz tone and subsequent weather report on one of the NOAA weather channels. You may enable this feature via Setup Menu Item “**WX ALERT 53**” (USA version only).

Memory Operation

The FTM-7250DR provides a wide variety of memory system resources. These include:

- ❑ 199 “basic” memory channels, numbered “1” through “199”.
- ❑ 6 “Home” channels. A Home Channel can be set and recalled on each frequency band.
- ❑ 10 sets of band-edge memories, also known as “Programmable Memory Scan” channels, labeled “L0/U0” through “L9/U9”.

Each memory may be appended with an alphanumeric label of up to 8 characters, for quick channel recognition.

Memory Storage

1. In the VFO mode, select the desired frequency and the communication mode to be registered to a memory channel.

2. Press and hold the [V/M(MW)] key.

A memory number will appear in the bottom right corner of the display.

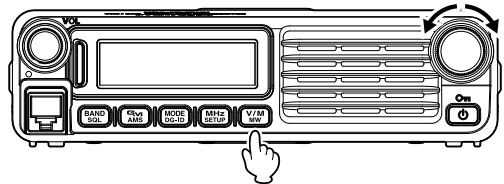

Note: If the channel number is blinking, there currently is no data stored on that channel; if the channel number is not blinking, that channel is currently “occupied” by other frequency data.

3. Rotate the **DIAL** knob to select the desired memory into which you wish to store the frequency.



Note: While operating in the Memory Storage mode, the keypad of the MH-48A6JA Microphone may be used to enter the memory channel number directly.

To do this, enter the desired Channel Number on the keypad. Refer to the “For example” of the “Memory Recall from the Microphone Keypad” on page 27.

4. Press the [V/M(MW)] key.

The memory tag input screen will be displayed on the display.

If not entering a nametag ➡ proceed to step 8.

5. Rotate the **DIAL** knob to select the first digit of the desired label.

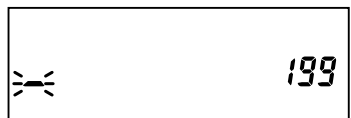

6. Press the [V/M(MW)] key to move to the next character.



To make a correction, press the [BAND(SQL)] key to move the cursor to the left, then re-enter the correct letter, number, or symbol.

7. Repeat steps 5 through 6 to program the re-main-ing letters, numbers, or symbols of the desired label. A total of 8 characters may be used in the creation of a label.

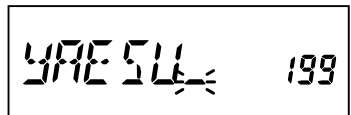

- Press and hold the **[V/M(MW)]** key, to store the displayed data into the selected memory channel slot.

Split Memory

A separate transmit frequency may be registered to a memory channel to which a receive frequency has already been registered.

Note: For details, refer to the Advanced Manual (download from the Yaesu website).

Memory Recall

Once the desired frequencies are stored into memory channels, switch from the “VFO” mode to the “Memory Recall” mode, to operate on the just-stored memory channels.

- Press the **[V/M(MW)]** key, repeatedly if necessary, until the “**MR**” icon and a memory channel number appear on the display; this indicates that the “Memory Recall” mode is now engaged.

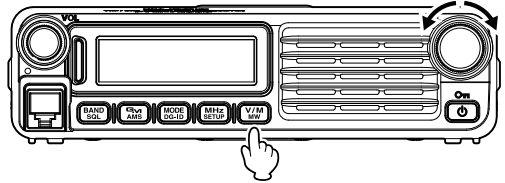

- When more than one memory has been stored, use the **DIAL** knob to select any of the programmed memories for operation.



Note:

- Alternatively, the microphone **[UP]** or **[DWN]** key may be used to step or scan through the available memories. When using the microphone keys, press the key momentarily to move one step up or down; press and hold the **[UP]** or **[DWN]** key to begin memory scanning.
- While operating in the Memory Recall mode, press the **[MHz(SETUP)]** key to toggle the display between indication of the frequency, and indication of the Alpha/Numeric label.

Memory Recall from the Microphone Keypad

While operating in the Memory Recall mode, the keypad of the MH-48A6JA Microphone may be used for direct recall of memory channels.

To do this, enter the desired Channel Number on the keypad.

For example: To recall Memory Channel “7”, press **[0] [0] [7]** or **[7] [#]**

To recall Memory Channel “123”, press **[1] [2] [3]**

You may also recall Programmable Memory Scan (PMS) channels (“L0/U0” through “L9/U9”) by entering the channel numbers listed in the below table:

L1	201	L3	205	L5	209	L7	213	L9	217
U1	202	U3	206	U5	210	U7	214	U9	218
L2	203	L4	207	L6	211	L8	215	L0	219
U2	204	U4	208	U6	212	U8	216	U0	220

Memory Operation

Moving Memory Data to the VFO

Data stored on memory channels can easily be moved to the VFO.

Note: For details, refer to the Advanced Manual (download from the Yaesu website).

Memory Only Mode

Once memory channel programming has been completed, you may place the radio in a “Memory Only” mode, whereby VFO operation is impossible.

Note: For details, refer to the Advanced Manual (download from the Yaesu website).

Masking Memories

There may be situations where you want to “Mask” memories so they are not visible during memory selection or scanning. (except for Memory Channel “1”, the Priority Channel, and the Home Channel).

1. In the Memory Recall mode, press and hold the [V/M(MW)] key, then rotate the **DIAL** knob to select the memory channel you wish to mask.
2. Press the [BAND(SQL)] key.
The erase confirmation screen appears.
3. Press the [BAND(SQL)] key.
The previously selected memory will be “masked”.

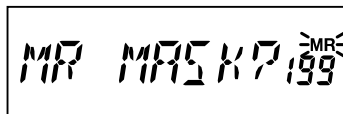
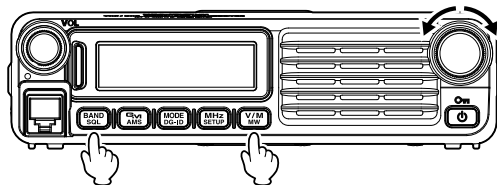

Note: Press any key, other than [BAND(SQL)], to cancel the memory mask.

Unmasking Memories

1. To Unmask a hidden memory, in the Memory Recall mode, press and hold the [V/M(MW)] key.
2. Rotate the **DIAL** knob to select the masked memory number.
3. Press the [BAND(SQL)] key to restore the memory channel data.

HOME Channel Memory

A convenient “Home” channel memory is available to simplify returning to an often used frequency.

To recall the Home channel, just press the [V/M(MW)] key, repeatedly if necessary, until the “HM” icon appears on the display.

“HM” and the home channel frequency of the currently selected band appears on the LCD.

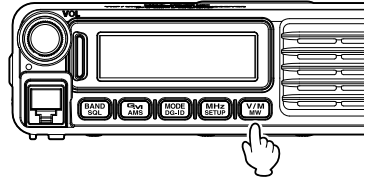

Changing the frequency of the home channel

The default frequency setting of the home channel can be changed.

1. In the VFO mode, tune to the desired Home channel frequency.
2. Press and hold the [V/M(MW)] key.
3. Press the [GM(AMS)] key.

The overwrite confirmation screen appears.

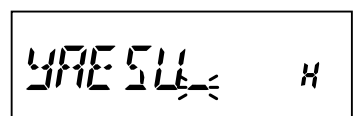
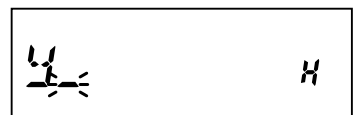
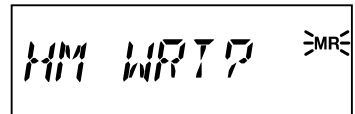
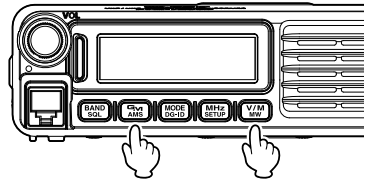

4. Press the [GM(AMS)] key.
The HOME channel tag input screen will be displayed.
If not entering a nametag → proceed to step 8.
5. Rotate the **DIAL** knob to select the first digit of the desired label.
6. Press the [V/M(MW)] key to move to the next character.
7. Repeat steps 5 through 6 to program the remaining letters, numbers, or symbols of the desired label. A total of 8 characters may be used in the creation of a label.
8. Press and hold the [GM(AMS)] key.
The home channel frequency is overwritten.

Basic Scanner Operation

Before activating the scanner, make sure that the Squelch is set to silence the background noise when no signal is present. Scanning is not possible while the Squelch is open (if noise or signals are being heard).

Scanning may be started or stopped using the microphone [UP] or [DWN] key.

The following techniques are used for scanning:

- in the **VFO mode**, press and hold either the [UP] or [DWN] key, to start upward or downward scanning of the band.
- In the **Memory mode**, press and hold either the [UP] or [DWN] key, to start channel scanning toward a higher or lower-numbered memory channel, respectively.
- Scanning pauses when a signal opens the squelch, and the decimal point on the display will blink. You can choose one of three scan resume modes.
- To halt the scan manually, the easiest way is to push the **PTT** switch on the microphone momentarily (no transmission will occur while you are scanning). The scan may also be halted manually by pressing the microphone [UP] or [DWN] key, or the [V/M(MW)] key.

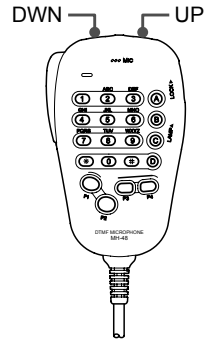

Scan Resume Options

Select which of the three resume scan modes is to be performed after the scanning stops.

Note: For details, refer to the Advanced Manual (download from the Yaesu website).

Memory Skip Scanning

Memory channels which you do not want to receive can be skipped during scanning.

Note: For details, refer to the Advanced Manual (download from the Yaesu website).

Preferential Memory Scan

Set up a “Preferential Scan List” of channels which you can “flag” within the memory system.

Note: For details, refer to the Advanced Manual (download from the Yaesu website).

Programmable Memory Scan (PMS)

Using the dedicated PMS memory channels, only the frequencies within the specified frequency range will be scanned.

Note: For details, refer to the Advanced Manual (download from the Yaesu website).

Priority Channel Scanning (Dual Watch)

Scanning features include a two-channel scanning capability which allows you to operate on a VFO, Memory channel, or Home channel, while periodically checking a user defined Memory Channel for activity.

Note: For details, refer to the Advanced Manual (download from the Yaesu website).

What is the GM (Group Monitor) Function?

The GM function automatically monitors the channel for any other stations with the GM function in operation on the same frequency, or stations transmitting in DN mode that are within communication range. You can be notified of GM stations operating within communications range, and the detected call signs are displayed on the transceiver screen,

Caution: The GM function does not work while in the analog (FM) mode.

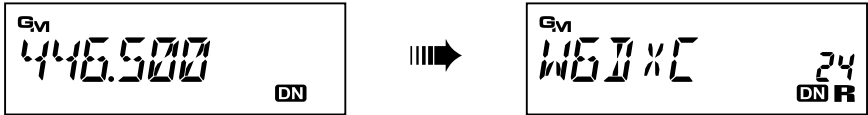

Displaying all the stations using the GM function

1. Tune to the designated frequency.
2. Press the **[GM(AMS)]** key.

The GM function is activated, and up to 24 stations using the GM mode, or stations operating in DN mode on the channel frequency, within the communication range are displayed.

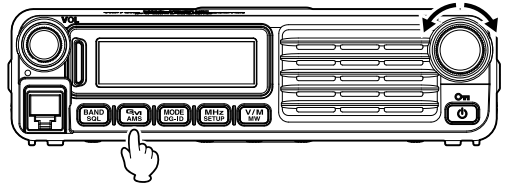

- Displays **"R"** for stations within your communication range.
- Displays **"R"** (blinks) for stations outside of your communication range.
- Turn the **DIAL** knob to select a station and display its communication range information.



3. Press the **[GM(AMS)]** key to disable the GM function and return to the frequency screen.

Note: Refer to the Advanced Manual for other details on using the GM function (download the Advanced Manual from the Yaesu website).

Reset Procedure/Clone

Reset Procedure

In some instances of erratic or unpredictable operation, the cause may be corruption of data in the microprocessor (due to static electricity, etc.). If this happens, resetting the microprocessor may restore normal operation. Note that all memories will be erased if you do a complete microprocessor reset, as described below.

Microprocessor Resetting

To clear all memories and other settings to factory defaults:

1. Turn the radio OFF.
2. Press and hold the [MODE(DG-ID)], [MHz(SETUP)], and [V/M(MW)] keys while turning the radio on. The “ALL RESET PUSH V/M KEY” notation will scroll on the display.



ALL RESET PUSH V/M KEY

3. Press the [V/M(MW)] key momentarily to reset all settings to their factory defaults (press any other key to cancel the Reset procedure).

Setup (Menu) Mode Resetting

To reset the Setup (Menu) Mode settings to their factory defaults, while leaving other settings unchanged:

1. Turn the radio OFF.
2. Press and hold the [MODE(DG-ID)] and [MHz(SETUP)] keys while turning the radio on. The “SET MODE RESET PUSH V/M KEY” notation will scroll on the display.



SET MODE RESET PUSH V/M KEY

3. Press the [V/M(MW)] key momentarily to reset the Setup (Menu) Mode settings to their factory defaults (press any other key to cancel the Reset procedure).

Clone

The FTM-7250DR includes a convenient “Clone” feature, which allows the memory and configuration data from one transceiver to be transferred to another FTM-7250DR.

This can be particularly useful when configuring a number of transceivers for a public service operation.

Note: For details, refer to the Advanced Manual (download from the Yaesu website).

What is WIRES-X?

WIRES-X is an Internet communication system which expands the range of amateur radio communication. You may employ Internet communications by connecting from your transceiver to a WIRES-X local node station.

* **FTM-7250DR** does not accommodate the transmission/reception of messages, images, audio messages, or location information.

Connecting to a WIRES-X digital node (Recommended)

* Ascertain the DSQ code or the DG-ID setting of the WIRES-X node station. Connecting to the WIRES-X node requires the transceiver DG-ID be set according to the DSQ code or the DG-ID code set on the WIRES-X node station.

* Confirm that the operating mode of WIRES-X node has been set to the C4FM digital mode.

1. Set the transmit/receive DG-ID to the same ID number as the node station.

For more details on the DG-ID number, see page 18

2. Transmit on the corresponding transmit/receive frequency.

- If the signal is received from the node, continue to transmit using the DG-ID setting as is.

- If the signal is not received from the node, ► proceed to “Connecting to the other node ID or the other room ID”

Connecting to the other node ID or the other room ID

1. Press and hold the [MHz(SETUP)] key to enter the Setup Menu.

2. Rotate the **DIAL** knob to select “**W-DGID 56* (54)**”, then press the [MHz(SETUP)] key. (*: USA version)

3. Rotate the **DIAL** knob to set the WIRES-X DG-ID to the same ID number as the node station.

Display	Description
DGID 01 - 99	Only nodes matching the set DG-ID number may be connected.
AUTO (default setting)	Only open nodes, set to the DG-ID number "00" may be connected.

4. Press the **PTT** switch, or press and hold the [MHz(SETUP)] key to save the new setting and return to normal operation.

5. Press the [P3] key.

“WIRES“ blinks.

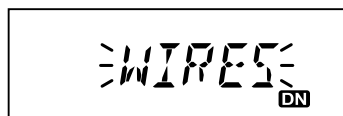

Connecting the WIRES-X feature

After successfully connecting to the node, one of the following screens is displayed indicating the node status.

1. Node ID screen (the Node Lc screen)

- This screen is displayed if the node is disconnected from the other node or the room on the Internet.
- The node station's node ID is displayed.
- Continue to select a connecting node ➡ proceed to step 6

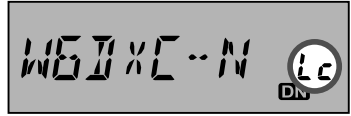

2. Connecting to a node ID or room ID screen (the Cn screen)

- This screen is displayed when the node has been connected to a node or room on the Internet.
- The connecting node station's node ID is displayed.
- If not changing the connecting node/room ➡ proceed to step 7.
- When changing the connecting node/room ➡ proceed to step 6.



Note: If the node connection is not successful, the beep sound is emitted and the transceiver returns to the normal operation.

6. Rotate the **DIAL** knob to select one of the connection screens (see below information), and connect to the desired node/room.

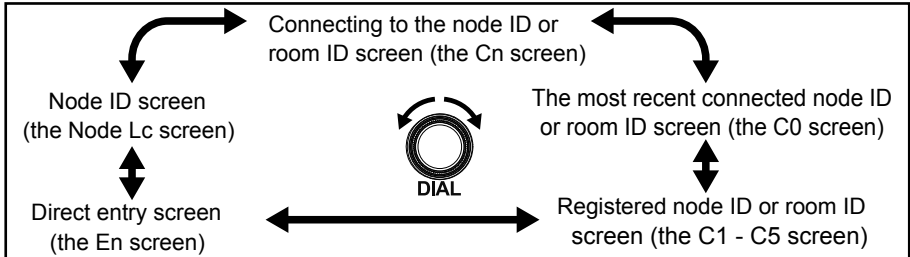

The most recent connected node ID or room ID screen (the C0 screen)

Most recent connected node ID or room ID is displayed. A single press of the [#] key on this screen will connect to the most recent node/room.



Registered node ID or room ID screen (the C1-C5 screen)

Rotate the **DIAL** knob to select a previously registered node/room (maximum 5 nodes/rooms) on the C1-C5 screen and, then press the [#] key or the PTT switch to connect to the node/room.



Connecting the WIRES-X feature

- **Registering the node/room:** Press and hold the [1]-[5] key to register the node/room (C1-C5) on the connected node ID or room ID (Cn).
- **Cancelling the connected node/room:** Select the node/room (C1-C5) then press and hold the [C] key to delete the registered node/room.

Direct entry screen (En)

Direct connection to a node or room may be made by inputting the other node ID or room ID (5 digits) manually.



- Pressing the numeric keys (5 digits), and then press the [#] key, will request connection with another node ID or room ID.
- **Clearing the input node ID or room ID:** Press and hold the [C] key
- **Cancelling the input node ID or room ID:** Pressing the [*] key to return to the node ID screen (Lc) or the connecting node ID or room ID screen.

Note: When a node has been connected, the node or room connection may be changed by inputting a different node ID or room ID.

When connecting to a node or room, "CONNECT" is displayed on the screen, and the display is automatically switched to the connecting node ID or room ID screen (Cn).



Note: In the case when the selected node or room is not connected, the screen will display one of the below icons.

"OFFLINE" (Node or room is not in operation.)

"BUSY" (Another node is connecting.)

7. Transmit to communicate with the WIRES-X Internet Link.

Note: Operations of the microphone [#], PTT, [*], and [A] keys, are described in the below chart:

Operation method (operation screen)	Description
Press the [#] key or the PTT switch (C0 / C1 to C5 / En screen*)	Connect to the displayed node/room or change the destination connection. (*The PTT switch is disabled on the En screen)
Press and hold the [*] key (Lc / Cn / C0 / C1 to C5 / En screen)	Disconnect from the connected node or room.
Press and hold the [1] to [5] key (Cn screen)	The connected node or room ID is registered to the memory of the number when it is pressed and held (In case the memory is already written, the registration is overwritten).
Press the [A] key (On activating WIRES-X)	Temporarily displays the operating frequency (when calling C4FM digital signal, the call sign of the other station is displayed). Press the [A] key again to return to the previous screen.

Connecting the WIRES-X feature

- When communication is completed, press and hold the microphone [P3] key to Exit WIRES-X mode.

Note: About WIRES-X open node stations

A listing of the WIRES-X open node stations, with their location, operation mode, etc. is posted on the Yaesu WIRES-X website.

<https://www.yaesu.com/jp/en/wires-x/index.php>

Connect and communicate with WIRES-X in analog mode

In analog mode, specify the connection destination using DTMF signals.

- In the normal operating screen, press the [MODE(DG-ID)] key to set the analog FM mode, and then tune to the frequency of the node station.

Note: When DTMF function is set to “AUTO” (☎ icon displayed on the LCD), change to “MANUAL” using the following steps.

Press and hold the [MHz(SETUP)] key \blacktriangleright Rotate the **DIAL** knob to select “**DT AUTO 16**” \blacktriangleright Press the [MHz(SETUP)] key \blacktriangleright Rotate the **DIAL** knob to select “**MANUAL**” \blacktriangleright Press and hold the [MHz(SETUP)].

- While holding down the **PTT** switch on the microphone, press the [#] key and then enter the 5 digit ID number of the node or room to be connected, the DTMF code will be sent to the node station.
- Keep the transceiver in receive mode for about 10 seconds. Once connection is established, you will be able to hear audio.

Note: The connected destination screen will not appear.

- Face the microphone and speak.

Disconnecting from the node or room

- While pressing the **PTT** switch, then enter the “#99999” (DTMF disconnect command) keys.

Note: *In analog mode, the excellent C4FM features such as clear voice, digital information etc cannot be used, so we recommend using digital C4FM when communicating with the WIRES-X Internet Linking System.*

Tone squelch feature

The tone squelch opens the speaker audio only when a signal containing the specified CTCSS tone is received. By matching the tone frequency with the partner station in advance, a quiet standby is possible.

Note: For details, refer to the Advanced Manual (download from the Yaesu website).

Digital Code squelch (DCS) feature

DCS (Digital Coded Squelch) function that allows audio to be heard only when signals containing the same DCS code are received.

Note: For details, refer to the Advanced Manual (download from the Yaesu website).

EPCS (Enhanced Paging & Code Squelch) Operation

Use the pager code consisting of two CTCSS tones to exchange communications with specified stations.

Note: For details, refer to the Advanced Manual (download from the Yaesu website).

Programming the Key Assignments

Default FTM-7250DR key functions have been assigned to the Microphone's [P3]/[P4] keys at the factory. The user may change these key function assignments, if quick access to another function is desired.

Note: For details, refer to the Advanced Manual (download from the Yaesu website).

Keyboard Beeper

A key/button beeper provides useful audible feedback whenever a key/button is pressed. If you want to turn the beeper off (or back on again).

Note: If you want to turn the beeper off (or back on again), see Setup Menu Item "BEP KEY 3" on 39.

Display Brightness

You can adjust the display brightness.

Note: See Setup Menu Item "LCD DMMR 23" on 40.

Time-Out-Timer (TOT)

The "Time-Out Timer" (TOT) feature is designed to force the transceiver into the "receive" mode after a preset time period of continuous transmission (the default is 3 minutes).

Note: See Setup Menu Item "TOT 48" on 41.

Automatic Power Off (APO)

The "Automatic Power-Off" (APO) feature will turn the radio completely off after a user defined period of PTT switch or key/button inactivity.

Note: See Setup Menu Item "APO 1" on 39.

Busy Channel Lock-Out (BCLO)

The BCLO feature prevents the transmitter from being activated whenever a signal strong enough to break through the "noise" squelch is present on the frequency.

Note: See Setup Menu Item "BCLO 2" on 39.

Miscellaneous Settings

TX Deviation Level

You can reduce the receiver bandwidth and transmit deviation when operating on closely spaced frequencies (channel spacing of 12.5 or 15 kHz). The reduced transmitter deviation will minimize adjacent channel interference to other users.

Note: See Setup Menu Item “**W/N DEV 55* (53)**” on 41. (*: USA version)

Displaying the Supply Voltage

Display the Power Supply voltage.

Note: See Setup Menu Item “**DC VOLT 9**” on 39.

MIC Gain Setting

At the factory, the microphone gain has been programmed so that it should be satisfactory for the supplied MH-48A6JA Microphone. If you use an after-market microphone or connect a TNC, you may wish to set a different Mic Gain level.

Note: See Setup Menu Item “**MIC GAIN 25**” on 40.

Displaying the Temperature

Indicates the current final transistor & heatsink temperature.

A temperature below 25°C (77°F) will be indicated as 25°C (77°F).

Note: See Setup Menu Item “**TEMP 46**” on 41.

Band Edge Beeper

The FTM-7250DR will automatically “beep” when the receiver’s band edge is encountered during scanning (either in standard VFO scanning or during PMS operation). You may additionally enable this feature (band edge beeper) when the frequency reaches the band edge while selecting the VFO frequency manually, using the **DIAL** knob.

Note: For details, refer to the Advanced Manual (download from the Yaesu website).

Split Tone Operation

The FTM-7250DR can be operated in a “Split Tone” configuration that enables operation on repeaters using a mix of both CTCSS and DCS control via the Setup menu.

Note: For details, refer to the Advanced Manual (download from the Yaesu website).

DTMF Operation

DTMF tones (Dual Tone Multi Frequencies) are the tones you hear when dialing from a telephone keypad. The FTM-7250DR transceiver can transmit the DTMF codes by using the keys on the microphone or recalling registered number strings from memories.

The maximum of 16-digit DTMF codes can be registered in up to 10 memory channels. It is convenient to register telephone patch numbers, and network linking sequences to the DTMF memory channels.

Note: For details, refer to the Advanced Manual (download from the Yaesu website).

Setup (Menu) Mode

The FTM-7250DR Setup (Menu) mode, already described in parts of many previous chapters, is easy to activate and setup. The Menus may be used to configure many of transceiver parameters, some of which have not been detailed previously. Use the following procedure to activate the Setup (Menu) mode:

1. Press and hold the **[MHz(SETUP)]** key to enter the Setup menu.
2. Rotate the **DIAL** knob to select the Menu Item to be adjusted.
3. Press the **[MHz(SETUP)]** key momentarily to enable adjustment of the selected Menu item, and then rotate the **DIAL** knob to perform the actual adjustment.

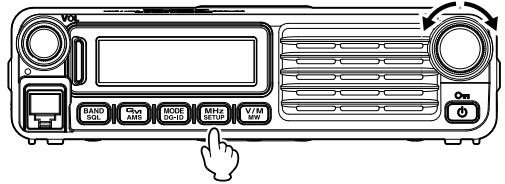

4. After completing the selection and adjustment, press and hold the **[MHz(SETUP)]** key to exit the Setup menu and resume normal operation.

Note: For details, refer to the Advanced Manual (download from the Yaesu website).

Menu Item		Function	Available Values	Default
1	APO	Enables/Disables the Automatic Power Off feature.	0.5H to 12H (0.5H step)/OFF	OFF
2	BCLO	Enables/Disables the Busy Channel Lock-Out feature.	ON/OFF	OFF
3	BEP KEY	Enables/Disables the key beeper.	KEY+SCAN/KEY/OFF	KEY+SCAN
4	BEP EDGE	Enables/Disable the Band-edge beeper while scanning.	ON/OFF	OFF
5	BEP LVL	Sets the beep level	HIGH/LOW	HIGH
6	BEP STBY	Enables/Disable the Standby beep	ON/OFF	ON
7	BELL	Selects the CTCSS/DCS/EPCS Bell Ringer repetitions.	1 to 20/CONTINUE/OFF	OFF
8	CLK TYPE	Shifting of the CPU clock frequency.	A/B	A
9	DC VOLT	Indicates the DC Supply Voltage.	---	---
10	DCS CODE	Setting of the DCS code.	104 standard DCS codes	023
11	DCS INV	Select a combination of DCS inversion codes in terms of communication direction.	NORMAL/INVERT/BOTH	NORMAL
12	DIG AMS	Sets the transmission mode	TXMANUAL/TX FMFIX/TX DIGTL/AUTO	AUTO
13	DIG VW	Turn the VW mode selection ON or OFF.	ON/OFF	OFF
14	DI POPUP	Sets the information pop-up time	2/4/6/8/10/20/30/60/CONTINUE/OFF	10 SEC
15	DPID LST	DP-ID list (Display/Register/Clear)	(Registered DP-ID)	---
16	DT AUTO	Enables/Disables the DTMF Autodialer feature.	MANUAL/AUTO	MANUAL

Setup (Menu) Mode

Menu Item		Function	Available Values	Default
17	DT DELAY	Setting of the DTMF Autodialer TX Delay Time.	50/250/450/750/1000	450 MS
18	DT SET	Loading of the DTMF Autodialer Memories.	---	---
19	DT SPEED	Setting of the DTMF Autodialer Sending Speed.	50/100	50 MS
20	DW RVRT	Enables/Disables the "Priority Channel Revert" feature.	ON/OFF	OFF
21	GM RINGR	Enables/Disables the alert sound when detecting stations within communication range	IN RANGE/ALWAYS/OFF	IN RANGE
22	GM INTVL	Selects the automatic sending interval.	NORMAL/LONG	NORMAL
23	LCD DMMR	Setting of the front panel display illumination level.	LEVEL 1/2/3/4	LEVEL 4
24	LOCK	Selects the Control Locking Lockout combination.	KEY + DIAL / PTT / KEY+PTT/DIAL+PTT / ALL/KEY/DIAL	KEY+DIAL
25	MIC GAIN	Adjust the microphone gain level.	LEVEL 1 to 9	LEVEL 5
26	MEM NAME	Programming an Alpha/Numeric label for a Memory Channel.	---	---
27	MW MODE	Selects the method of selecting of channels for Memory Storage.	NEXT CH/LOWER CH	NEXT CH
28	OPEN MSG	Selects the Opening Message that appears when the radio is powered ON.	OFF/DC/MESSAGE	MESSAGE
29	PAG CD-R	Setting the Receiver Pager Code for the Enhanced CTCSS Paging & Code Squelch function.	---	05 47
30	PAG CD-T	Setting the Transmitting Pager Code for the Enhanced CTCSS Paging & Code Squelch function.	---	05 47
31	PRG P3	Programming the function assigned to Microphone [P3] key.	SQL OFF HOME WX CH ^{※2} CD SRCH SCAN T CALL TX POWER	WIRES-X
32	PRG P4	Programming the function assigned to Microphone [P4] key.	MODE GM WIRES-X REV DW Setup Menu Item #1 to 57 (except 31 and 32)	※1
33	RADIO ID	Displays the transceiver IDs	※※※※ (uneditable)	---
34	RF SQL	Adjusts the RF Squelch threshold level.	OFF/S1 to S8	OFF
35	RPT ARS	Activates/Deactivates the Automatic Repeater Shift feature.	ON/OFF	ON

Setup (Menu) Mode

Menu Item	Function	Available Values	Default	
36	RPT FREQ	Sets the magnitude of the Repeater Shift.	0.00 - 150.00 (MHz)	※1
37	RPT SFT	Sets the Repeater Shift direction.	-RPT/+RPT/SIMPLEX	+RPT
38	RX MODE	Select the receive mode.	AUTO/FM/AM	AUTO
39	SCAN RSM	Selects the Scan Resume mode.	BUSY/HOLD/2-10 (SEC)	5.0 SEC
40	SCAN SKP	Selects the Memory Scan mode.	OFF/SKIP/SELECT	OFF
41	SCNW MEM	Set the memory scan frequency range.	ALL/BAND	ALL
42	SCNW VFO	Set the VFO scan frequency range.	ALL/BAND	BAND
43	SQL EXP	Enables/Disables the split CTCSS/DCS coding.	ON/OFF	OFF
44	SQL TYPE	Selects the Tone Encoder and/or Decoder mode.	TONE/TSQ/DCS/ RV TONE/PAGER/OFF	OFF
45	STEP	Sets the frequency synthesizer steps.	AUTO/5/6.25/10/12.5/15 /20/25/50/100 (kHz)	AUTO
46	TEMP	Indicates the final transistor & heatsink temperature.	---	---
47	TONE FRQ	Setting of the CTCSS Tone Frequency.	67.0 to 254.1 (Hz)	100.0 HZ
48	TOT	Sets the Time-Out Timer.	0.5 to 10.0 (MIN)/OFF	3.0 MIN
49	TS MUTE	Enables/Disables the receiver audio output while the Tone Search or DCS Search Scanner is activated.	ON/OFF	ON
50	TS SPEED	Selects the Tone Search or DCS Search Scanner speed.	FAST/SLOW	FAST
51	VER DISP	Displays the transceiver software version	CPU x.xx DSP x.xx	---
52	VFO MODE	Set the frequency setting range in the VFO mode by DIAL knob.	ALL/BAND	BAND
53※2	WX ALERT	Enables/Disables the Weather Alert feature.	ON/OFF	OFF
54※2	WX VOL	Selects the audio output level of the Weather Alert.	NOR VOL/MAX VOL	NOR VOL
55※2 (53)	W/N DEV	Reduction of the Microphone Gain/Deviation and receiver bandwidth.	WIDE/NARROW	WIDE
56※2 (54)	W-DGID	Setting of the WIRELESS-X DG-ID	AUTO/DGID01 - 99	AUTO
57※2 (55)	MY CALL	Sets your station call sign	-----	---

※1: Depends on the transceiver version.

※2: USA version.

Care and maintenance

Turn the power OFF before wiping away any dust and stains on the transceiver with a dry soft cloth. For stubborn stains, slightly moisten a soft cloth and wring it out before using it to wipe away the stains.

Caution: Never use washing detergents and organic solvents (thinner, benzene, etc.). Doing so may result in paint flaking or damage to the transceiver finish.

Replacing the fuse

When the fuse of the DC power supply cable blows and the transceiver becomes inoperable, correct the cause of the problem, and then replace the fuse with a new one of the correct rating (15 A).

Caution: When replacing the fuse, be sure to disconnect the power supply cable from the transceiver and from the external DC power supply.

Replacing the fuse of the DC power supply cable

1. Prepare a new fuse.

Use a fuse with a rating of 15 A.

Caution: Never attempt to use a fuse that is not of the specified rating.

2. Open the fuse holder as shown in the diagram on the right.
3. Remove the blown fuse.
4. Attach the new fuse.
5. Close the fuse holder.

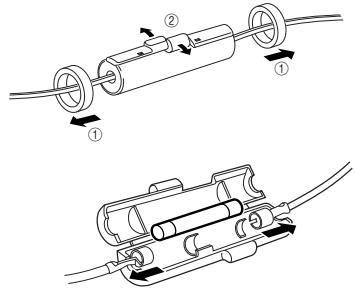

General

Frequency Range:	Tx 144 - 146 or 144 - 148 MHz 430 - 440 or 430 - 450 MHz Rx 108 - 579.995 MHz
Channel Step:	5/6.25/(8.33)/10/12.5/15/20/25/50/100 kHz () Air Band
Standard Repeater Shift:	VHF: ± 600 kHz UHF: $\pm 5 / 1.6 / 7.6$ MHz
Frequency Stability:	± 2.5 ppm [-4 °F to $+140$ °F (-20 °C to $+60$ °C)]
Modes of Emission:	F2D/F3E/F7W
Antenna Impedance:	50 Ohms, unbalanced
Supply voltage:	13.8 V DC $\pm 15\%$, negative ground
Current Consumption (typical):	Rx: less than 0.5 A Tx: 10 A (50 W) /6 A (25 W) /4 A (5 W)
Operating Temperature Range:	-4 °F to $+140$ °F (-20 °C to $+60$ °C)
Case Size (WxHxD) (approx.):	6.1" x 1.7" x 5.7" (155 x 42 x 145.5 mm) (w/o knobs and FAN)
Weight (approx.):	2.86 lb (1.3 kg)

Transmitter

Output Power:	50/25/5 W
Modulation Type:	F2D/F3E: Variable Reactance F7W: 4FSK (C4FM)
Maximum Deviation:	± 5 kHz (Wide) ± 2.5 kHz (Narrow)
Spurious Radiation:	Better than -60 dB
Microphone Impedance:	2k Ohms

Receiver

Circuit Type:	Double Conversion Superheterodyne
I _{fs} :	1st 47.25 MHz, 2nd 450 kHz
Sensitivity (for 12dB SINAD):	1.5 μ V typ for 10 dB SN (108 - 137 MHz, AM) 0.16 μ V for 12 dB SINAD (137 - 174 MHz, NFM) 1 μ V for 12 dB SINAD (174 - 222 MHz, NFM) 0.5 μ V for 12 dB SINAD (300 - 350 MHz, NFM) 0.2 μ V for 12 dB SINAD (350 - 400 MHz, NFM) 0.18 μ V for 12 dB SINAD (400 - 470 MHz, NFM) 0.35 μ V for 12 dB SINAD (470 - 580 MHz, NFM)
Sensitivity (for Digital):	0.19 μ V typ for BER 1 %
Selectivity ($-6/-60$ dB):	12 kHz/28 kHz
Maximum AF Output:	3 W into 4 Ohms with 10% THD

Specifications are subject to change without notice, and are guaranteed within the 144 and 430 MHz amateur bands only. Frequency ranges will vary according to transceiver version; check with your dealer.

YAESU LIMITED WARRANTY

Limited Warranty is valid only in the country/region where this product was originally purchased.

On-line Warranty Registration:

Thank you for buying YAESU products! We are confident your new radio will serve your needs for many years! Please register your product at www.yaesu.com - Owner's Corner

Warranty Terms:

Subject to the Limitations of the Warranty and the Warranty Procedures described below, YAESU MUSEN hereby warrants this product to be free of defects in materials and workmanship in normal use during the "Warranty Period." (the "Limited Warranty").

Limitations of Warranty:

- A. YAESU MUSEN is not liable for any express warranties except the Limited Warranty described above.
- B. The Limited Warranty is extended only to the original end-use purchaser or the person receiving this product as a gift, and shall not be extended to any other person or transferee.
- C. Unless a different warranty period is stated with this YAESU product, the Warranty Period is three years from the date of retail purchase by the original end-use purchaser.
- D. The Limited Warranty is valid only in the country/region where this product was originally purchased.
- E. During the Warranty Period, YAESU MUSEN will, at its sole option, repair or replace (using new or refurbished replacement parts) any defective parts within a reasonable period of time and free of charge.
- F. The Limited Warranty does not cover shipping cost (including transportation and insurance) from you to us, or any import fees, duties or taxes.
- G. The Limited Warranty does not cover any impairment caused by tampering, misuse, failure to follow instructions supplied with the product, unauthorized modifications, or damage to this product for any reasons, such as: accident; excess moisture; lightning; power surges; connection to improper voltage supply; damage caused by inadequate packing or shipping procedures; loss of, damage to or corruption of stored data; product modification to enable operation in another country/purpose other than the country/purpose for which it was designed, manufactured, approved and/or authorized; or the repair of products damaged by these modifications.
- H. The Limited Warranty applies only to the product as it existed at the time of the original purchase, by the original retail purchaser, and shall not preclude YAESU MUSEN from later making any changes in design, adding to, or otherwise improving subsequent versions of this product, or impose upon YAESU MUSEN any obligation to modify or alter this product to conform to such changes, or improvements.
- I. YAESU MUSEN assumes no responsibility for any consequential damages caused by, or arising out of, any such defect in materials or workmanship.
- J. TO THE FULLEST EXTENT PERMITTED BY LAW, YAESU MUSEN SHALL NOT BE RESPONSIBLE FOR ANY IMPLIED WARRANTY WITH RESPECT TO THIS PRODUCT.
- K. If the original retail purchaser timely complies with the Warranty Procedures described below, and YAESU MUSEN elects to send the purchaser a replacement product rather than repair the "original product", then the Limited Warranty shall apply to the replacement product only for the remainder of the original product Warranty Period.
- L. Warranty statutes vary from state to state, or country to country, so some of the above limitations may not apply to your location.

Warranty Procedures:

1. To find the Authorized YAESU Service Center in your country/region, visit www.yaesu.com. Contact the YAESU Service Center for specific return and shipping instructions, or contact an authorized YAESU dealer/distributor from whom the product was originally purchased.
2. Include proof of original purchase from an authorized YAESU dealer/distributor, and ship the product, freight prepaid, to the address provided by the YAESU Service Center in your country/ region.
3. Upon receipt of this product, returned in accordance with the procedures described above, by the YAESU Authorized Service Center, all reasonable efforts will be expended by YAESU MUSEN to cause this product to conform to its original specifications. YAESU MUSEN will return the repaired product (or a replacement product) free of charge to the original purchaser. The decision to repair or replace this product is the sole discretion of YAESU MUSEN.

Other conditions:

YAESU MUSEN'S MAXIMUM LIABILITY SHALL NOT EXCEED THE ACTUAL PURCHASE PRICE PAID FOR THE PRODUCT. IN NO EVENT SHALL YAESU MUSEN BE LIABLE FOR LOSS OF, DAMAGE TO OR CORRUPTION OF STORED DATA, OR FOR SPECIAL, INCIDENTAL, CONSEQUENTIAL, OR INDIRECT DAMAGES, HOW EVER CAUSED; INCLUDING WITHOUT LIMITATION TO THE REPLACEMENT OF EQUIPMENT AND PROPERTY, AND ANY COSTS OF RECOVERING, PROGRAMMING OR REPRODUCING ANY PROGRAM OR DATA STORED IN OR USED WITH THE YAESU PRODUCT.

Some Countries in Europe and some States of the USA do not allow the exclusion or limitation of incidental or consequential damages, or a limitation on how long an implied warranty lasts, so the above limitation or exclusions may not apply. This warranty provides specific rights, there may be other rights available which may vary between countries in Europe or from state to state within the USA.

This Limited Warranty is void if the label bearing the serial number has been removed or defaced.

- Changes or modifications to this device that are not expressly approved by YAESU MUSEN could void the user's authorization to operate this device.
- This device complies with part 15 of the FCC Rules. Operation is subject to the following two conditions: (1) This device may not cause harmful interference, and (2) this device must accept any interference including received, interference that may cause undesired operation.
- The scanning receiver in this equipment is incapable of tuning, or readily being altered, by the User to operate within the frequency bands allocated to the Domestic public Cellular Telecommunications Service in Part 22.
- The YAESU MUSEN is not responsible for any changes or modifications not expressly approved by the party responsible for compliance. Such modifications could void the user's authority to operate the equipment.

This device complies with ISSED's applicable license-exempt RSS standard(s). Operation is subject to the following two conditions: (1) this device may not cause interference, and (2) this device must accept any interference, including interference that may cause undesired operation of the device.

Le présent appareil est conforme aux CNR d'Industrie Canada applicables aux appareils radio exempts de licence. L'exploitation est autorisée aux deux conditions suivantes : (1) l'appareil ne doit pas produire de brouillage, et (2) l'utilisateur de l'appareil doit accepter tout brouillage radioélectrique subi, même si le brouillage est susceptible d'en compromettre le fonctionnement.

DECLARATION BY MANUFACTURER

The Scanner receiver is not a digital scanner and is incapable of being converted or modified to a digital scanner receiver by any user.

WARNING: MODIFICATION OF THIS DEVICE TO RECEIVE CELLULAR RADIOTELEPHONE SERVICE SIGNALS IS PROHIBITED UNDER FCC RULES AND FEDERAL LAW.

CAN ICES-3 (B) / NMB-3 (B)

This equipment has been tested and found to comply with the limits for a Class B digital device, pursuant to part 15 of the FCC Rules. These limits are designed to provide reasonable protection against harmful interference in a residential installation. This equipment generates, uses, and can radiate radio frequency energy; and, if not installed and used in accordance with the instructions, may cause harmful interference to radio communications. However, there is no guarantee that interference will not occur in a particular installation.

If this equipment does cause harmful interference to radio or television reception, which can be determined by turning the equipment off and on, the user is encouraged to try to correct the interference by one or more of the following measures:

- Reorient or relocate the receiving antenna.
- Increase the separation between the equipment and receiver.
- Connect the equipment into an outlet on a circuit different from that to which the receiver is connected.
- Consult the dealer or an experienced radio/TV technician for help.

YAESU

The radio

Copyright 2018
YAESU MUSEN CO., LTD.
All rights reserved.

No portion of this manual may be
reproduced without the permission of
YAESU MUSEN CO., LTD.

YAESU MUSEN CO., LTD.

Tennozu Parkside Building
2-5-8 Higashi-Shinagawa, Shinagawa-ku, Tokyo
140-0002 Japan

YAESU USA

6125 Phyllis Drive, Cypress, CA 90630, U.S.A.

YAESU UK

Unit 12, Sun Valley Business Park, Winnall Close
Winchester, Hampshire, SO23 0LB, U.K.

1802N-AS
Printed in Japan



E H 0 7 5 M 1 0 0