



Sunnydale Community Center SF Visual Arts Commission

May 15, 2024

CURRENT PHASE

Sunnydale Avenue Infrastructure

- 4-acre grading, street, utility project
- *Completion early 2024*

Community Center

- 30,000 SF community center
- Boys & Girls Club
- Wu Yee Children's Services
- Recording Studio
- Living Room & Multipurpose Rooms
- *Completion late 2024*

3A & 3B Mixed-Use Buildings

- 170 units affordable housing
- 20,000 SF ground floor commercial space
- *Completion Early 2025*

Herz Recreation Center

- 12,000 SF recreation center
- Full-size Basketball Court
- *Completion mid 2025*

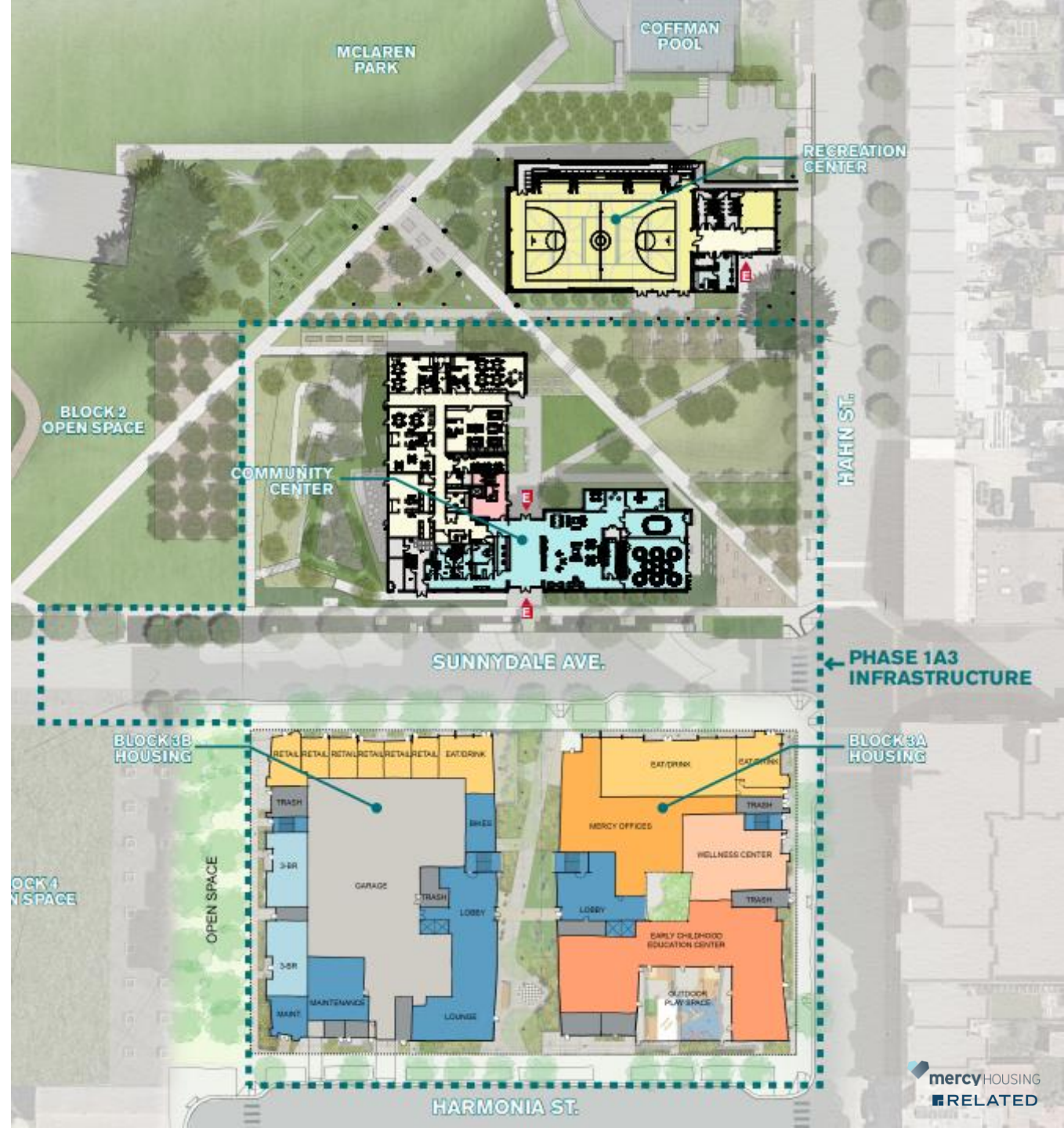

COMMUNITY CENTER & RECREATION CENTER



COMMUNITY CENTER & RECREATION CENTER

Community Center with Community Kitchen

Boys & Girls Club

Recreation Center with 10,000 square foot gym

Recording Studio

Wu Yee Early Childhood Education Center



Community Center



Sunnydale Avenue Main entrance

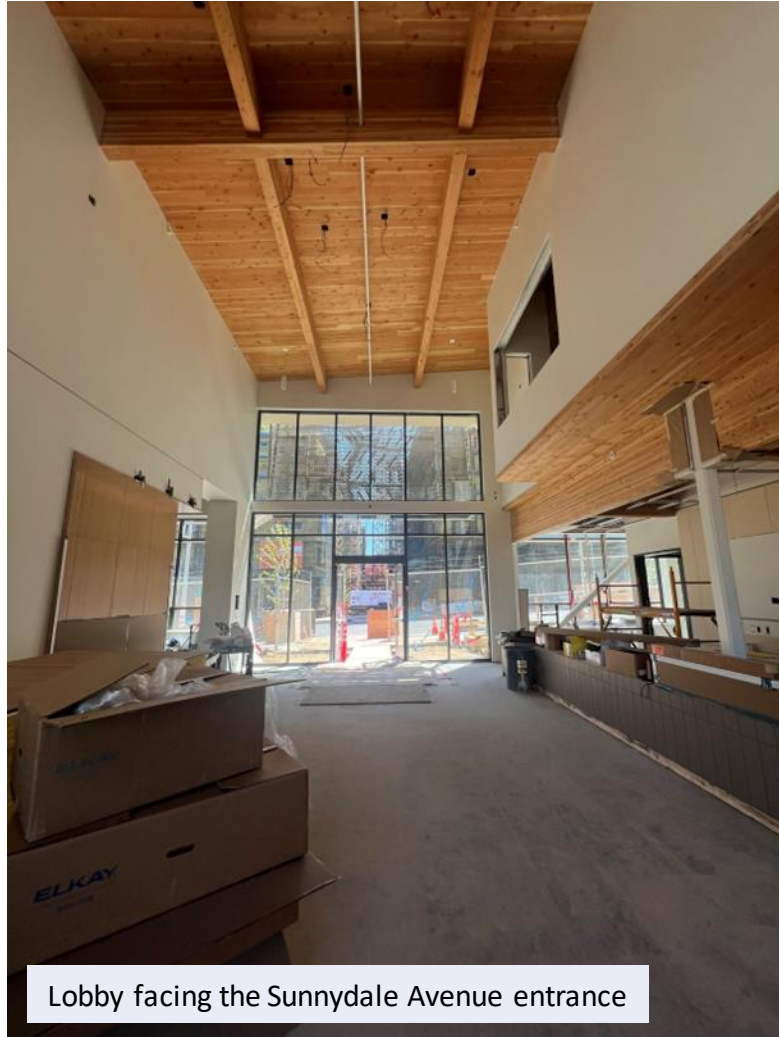

Lobby facing the Sunnydale Avenue entrance



Courtyard view

- Community center construction is expected to reach TCO in August 2024 and final completion in October 2024
- The development is 79% into construction

Current Conditions of the Benny Bufano Sculpture

April 17, 2024 at 3:01 PM
San Francisco - Crocker-Amazon - 5,018 of 5,019



April 17, 2024 at 3:01 PM
San Francisco - Crocker-Amazon - 5,019 of 5,019



April 17, 2024 at 3:01 PM
San Francisco - Crocker-Amazon - 5,017 of 5,019



Relocation

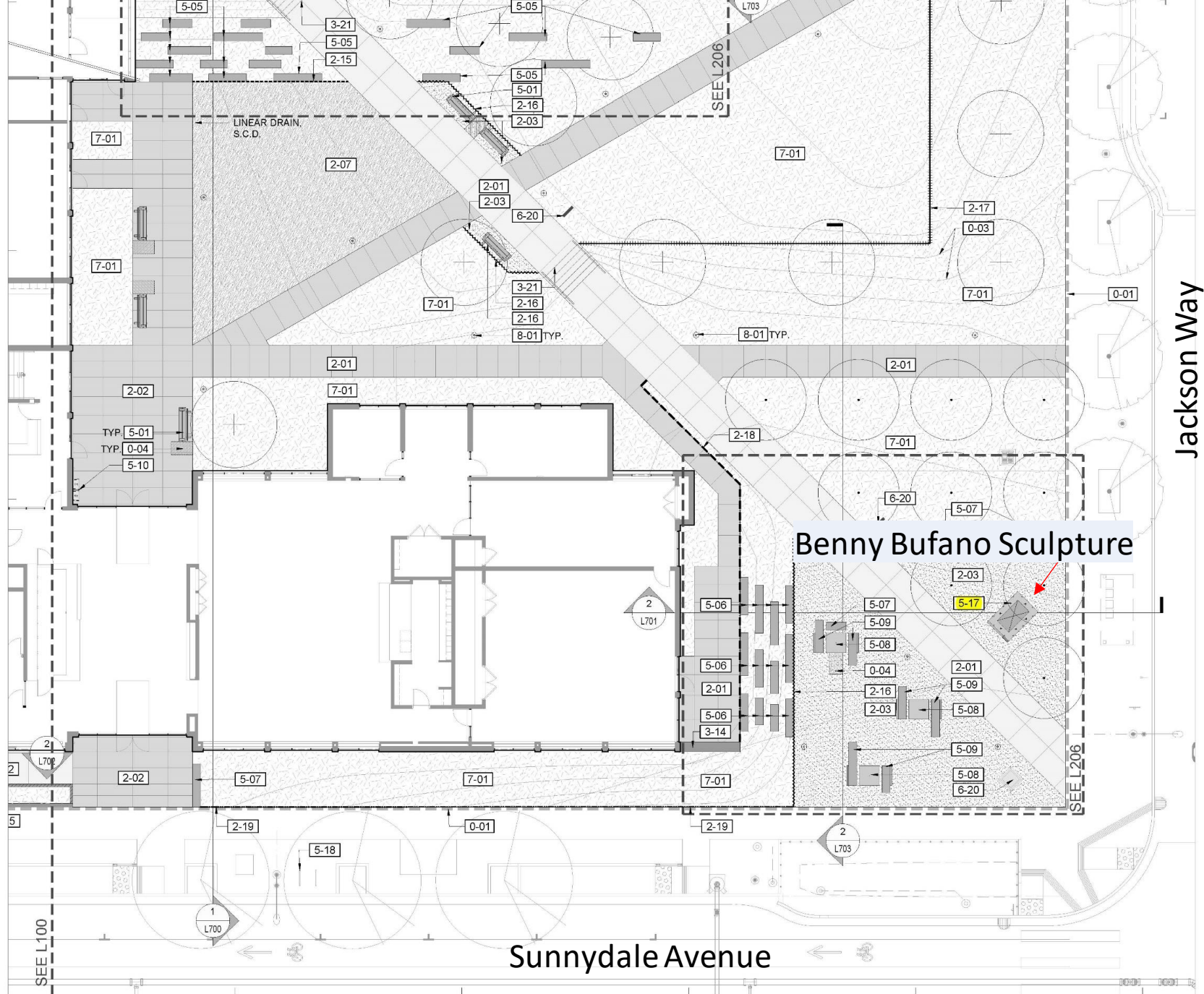

Jackson Way

Sunnydale Avenue

SYMBOL	DESCRIPTION
2-08	EWB PAVING
2-09	PLAY SURFACING
EDGES	
SYMBOL	DESCRIPTION
2-14	EDGE TYPE I
2-15	EDGE TYPE II
2-16	EDGE TYPE III
2-17	EDGE TYPE IV
2-18	EDGE TYPE V
2-19	EDGE TYPE VI
WALLS	
SYMBOL	DESCRIPTION
3-11	WALL TYPE I
3-12	WALL TYPE II
3-13	WALL TYPE III
3-14	WALL TYPE IV
3-15	WALL TYPE V
STAIRS	
SYMBOL	DESCRIPTION
3-21	STAIR TYPE I
3-23	STAIR TYPE 3
3-24	STAIR TYPE II
5 SITE FURNISHINGS	
SYMBOL	DESCRIPTION
5-01	BENCH
5-03	PICNIC TABLE
5-05	STONE ELEMENT TYPE I
5-06	STONE ELEMENT TYPE II
5-07	STONE ELEMENT TYPE III
5-08	STONE ELEMENT TYPE IV
5-09	STONE ELEMENT TYPE V
5-10	WASTE RECEPTACLES
5-11	RECLAIMED TIMBER ELEMENT
5-12	BOULDER
5-13	PLAYGROUND SLIDE
5-14	PLANTER
5-15	RECLAIMED WOOD STEPPER
5-16	WATER FOUNTAIN
5-17	BUFANO SCULPTURE PLINTH
5-18	BIKE RACKS
FENCES + GUARDRAILS	
SYMBOL	DESCRIPTION
6-01	FENCE TYPE I
6-02	GUARDRAIL
6-03	GATE TYPE I
6-04	GATE TYPE II
6-20	SIGNAGE ELEMENT
7 PLANTING	
SYMBOL	DESCRIPTION
7-01	PLANTING AREA
8 SITE LIGHTING	
SYMBOL	DESCRIPTION
8-01	SITE LIGHTING FIXTURE



Drawings

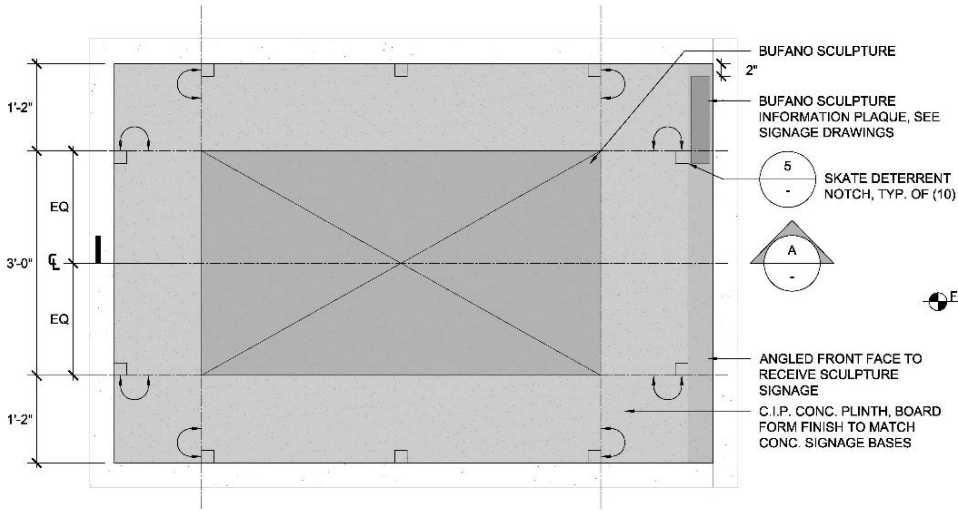

PLAN

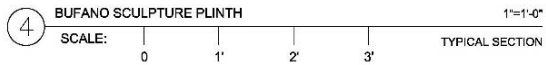

NOTE: FIELD VERIFY DIMENSIONS OF SCULPTURE. WEIGHT OF SCULPTURE TO BE DETERMINED TO FINALIZE PLINTH DIMENSIONS AND STRUCTURAL REQUIREMENTS.

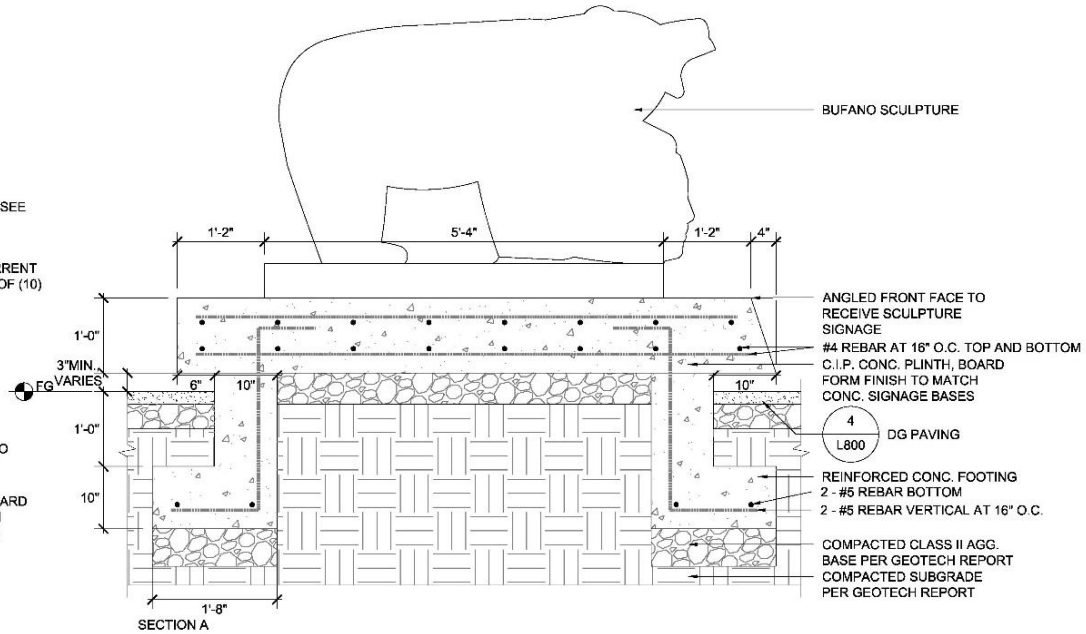

SECTION A

BUFANO SCULPTURE

ANGLED FRONT FACE TO RECEIVE SCULPTURE SIGNAGE

#4 REBAR AT 16" O.C. TOP AND BOTTOM
C.I.P. CONC. PLINTH, BOARD FORM FINISH TO MATCH CONC. SIGNAGE BASES

4
L800
DG PAVING

REINFORCED CONC. FOOTING
2 - #5 REBAR BOTTOM
2 - #5 REBAR VERTICAL AT 16" O.C.

COMPACTED CLASS II AGG. BASE PER GEOTECH REPORT
COMPACTED SUBGRADE PER GEOTECH REPORT

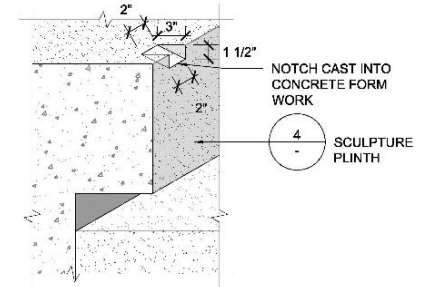

1-1/2"=1'-0"

Questions?